



Amendment List		Amended by	Date Incorporated
No	Date		
1			
2			
3			
4			
5			
6			
7			
8			
9			
10			
11			
12			
13			
14			
15			
16			

# ACP 33

## FLIGHT

### CONTENTS

Volume 1 .....History of Flight

Volume 2 .....Principles of Flight

---

**Volume 3 .....Propulsion**

---

Volume 4 .....Airframes

### Volume 3

## Propulsion

---

Chapter 1 .....The Piston Engine

Chapter 2 .....Carburation

Chapter 3 .....Ignition

Chapter 4 .....Lubrication and Cooling

Chapter 5 .....Propellers

Chapter 6 .....The Jet Engine

Chapter 7 .....Rockets

Instructors' Guide

---

---

## **ACKNOWLEDGEMENT**

Chapter 6 - "The Jet Engine" is a reproduction of a publication "How a Jet Engine Works", produced and supplied by Rolls-Royce Limited. We gratefully acknowledge their permission to print and other help given.

---

# CHAPTER 1

## THE PISTON ENGINE

### Introduction

#### **How it all started**

1. In 1903, the Wright brothers made history with the first powered aeroplane that could carry a man. Their flying machine was powered by a piston engine - and today, nearly a century later, piston engines are still used in hundreds of thousands of aircraft all over the world.

### Basic Principles

#### **Piston Engine Design**

2. There are many types of piston engine - one example is the old type of railway engine, where solid fuel (coal or wood) is burnt externally in a firebox, to turn water into steam which is then piped to the engine to drive the pistons. These external combustion engines are much too heavy for aviation, so we use the internal combustion engine, which obtains its power by burning liquid fuel inside the engine, where the pistons are located.

3. The piston engine is basically similar to a bicycle pump in that it has a cylinder, inside which is a sliding plunger or piston. Connect a bicycle pump to the tube of a tyre and force the plunger down the cylinder of the pump. The air inside the pump is both compressed and heated by the energy from your arm. If the plunger is released before the air has entered the tube, the energy in the hot compressed air will cause the plunger to spring back. In action, the piston inside the cylinder of an engine works like the plunger of the pump. First it compresses a "charge" of fuel and air inside the cylinder. Next, the fuel is burned inside the cylinder, and the heat energy released does work by moving the piston (Fig 1-1).

**Fig 1-1** Piston in Cylinder

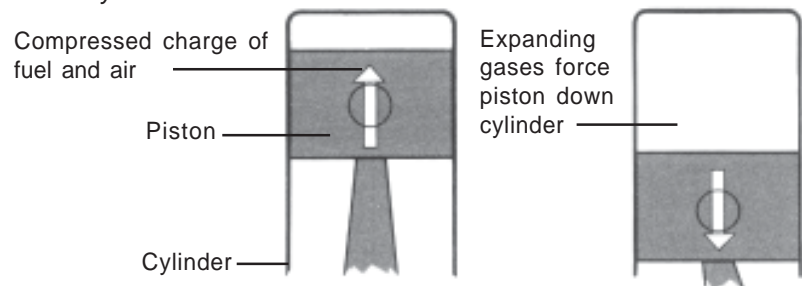

#### **Combustion**

4. Burning the charge is called "combustion. This is a chemical action in which the fuel combines with oxygen to release heat energy. But first it must be

set alight, or "ignited". Each fuel has an ignition temperature below which it will not burn. Moreover, although gasoline is a fuel which will burn at normal atmospheric temperatures, it gives better results if heated and compressed. Compressing the charge before ignition raises the temperature, which makes ignition easier and improves the rate at which the charge burns. This gives a great gain in power output and a marked reduction in fuel consumption.

5. When the charge burns rapidly, it expands rapidly, forcing the piston to move down the cylinder. This movement is the driving force of the engine - but the piston's movement is linear (ie a straight line), and we want to use it to make something rotate (eg a propeller), so what can we do? Two simple cases of a linear force producing a rotary movement are seen in everyday use:

- a. The spanner.
- b. The bicycle pedal and crank.

**Fig 1-2** Linear Forces Producing Rotation

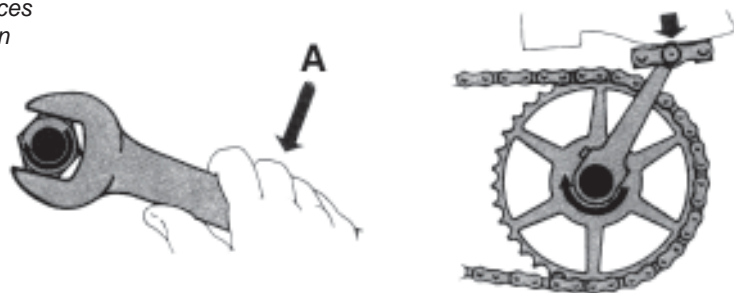

When a force is applied in the direction of arrow A (Fig 1-2), the spanner makes the nut revolve around the bolt - a linear force has brought about rotation. Similarly a downward pressure upon the pedal of a cycle makes the gear wheel revolve.

**Fig 1-3** The Crankshaft

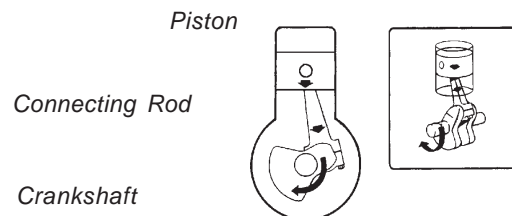

**The Crankshaft**

6. In a piston engine (Fig 1-3) we add a shaft with a crank (the crankshaft) and join it to the piston by a connecting rod. The piston movement now causes the crankshaft to rotate, so we can use the crankshaft to drive a propeller, or the wheels of a car. The rotating crankshaft also provides a means of returning the piston to

its starting point, so the piston can now produce its linear thrusting movement time after time.

**Fig 1-4** a. Inlet and Exhaust Passages, b. Valve Operation

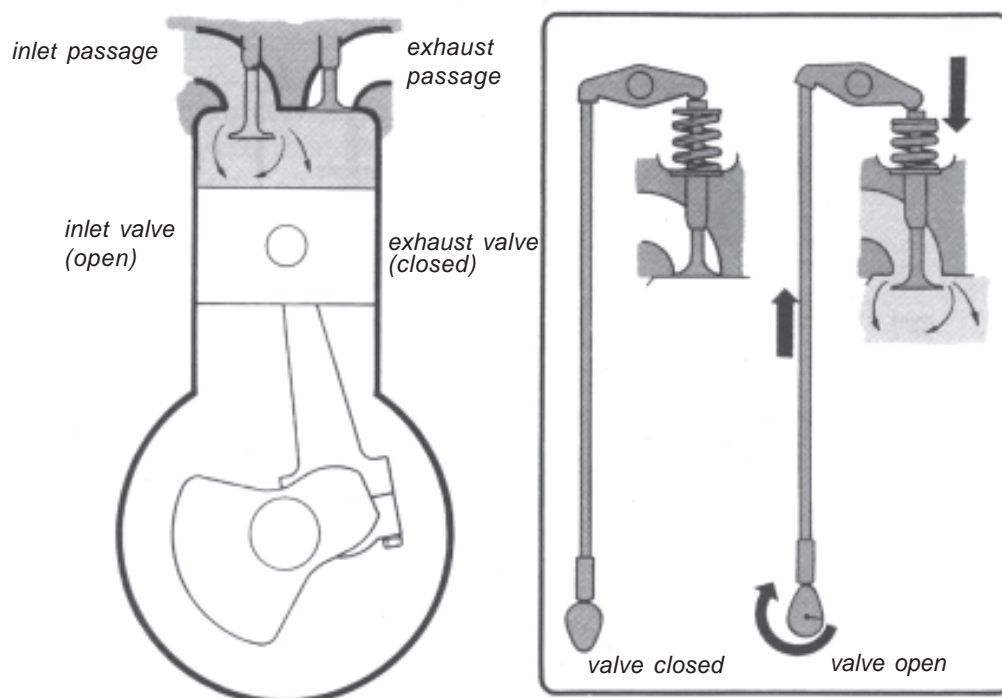

7. The engine needs an inlet passage so that a mixture of fuel and air can enter the cylinder, and an outlet passage (the exhaust) to allow the burnt gas to flow out to atmosphere (Fig 1-4). These passages are opened and closed by inlet and exhaust valves which are driven from the crankshaft. The valves open and close at different times - and we shall discuss that in more detail later - but first, to start the whole process, the crankshaft must be turned by external means until a fuel and air mixture has entered the cylinder and been compressed by the piston. The charge is then ignited by an electric spark, the mixture burns and expands, pushing the piston down and the engine continues to run under its own power.

8. At this stage, you need to know some technical terms:

a. Stroke. The "stroke" is the distance which the piston moves in the cylinder between the highest point, top dead centre (TDC) and the lowest point, bottom dead centre (BDC). For one downstroke the crankshaft turns 180° (ie one half of a crankshaft revolution), and for the return upstroke the crankshaft

rotates a further 180°

b. Bore. The "bore" is the diameter of the cylinder.

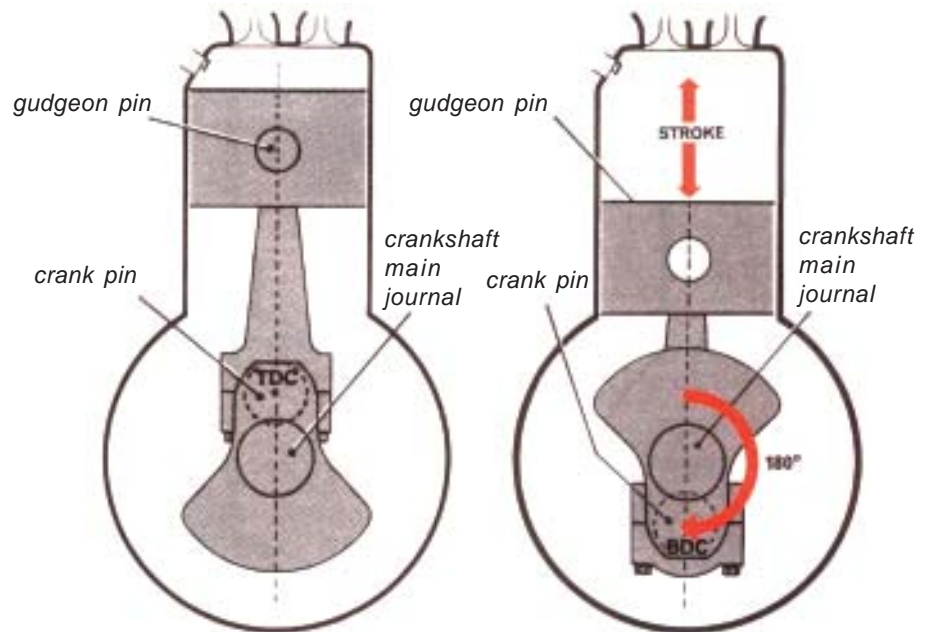

**Fig 1-5a** Top Dead Centre

**Fig 1-5b** Bottom Dead

c. Top Dead Centre. TDC is illustrated in Fig 1-5a. It occurs when the piston reaches the highest point of its travel and a straight line can be drawn through the centres of:

- (1) The gudgeon pin (which joins the connecting rod to the piston).
- (2) The crank pin (which joins the connecting rod to the crankshaft).
- (3) The crankshaft main journal (ie the central shaft of the crankshaft).

d. Bottom Dead Centre. BDC is illustrated in Fig 1-5b. It occurs when the piston reaches the lowest point of its travel and a straight line can be drawn through the centres of:

- (1) The gudgeon pin.
- (2) The crankshaft main journal.
- (3) The crank pin.



### The Four-Stroke Cycle

9. Fig 1-6 shows how it takes 4 strokes of the piston to take in the charge, compress it, burn it, and then exhaust the gases produced by combustion: the engine has completed a cycle of events called "the 4-stroke cycle". Once the starter motor has turned the engine through a full cycle the power stroke takes over. The cycles are then repeated in endless procession until the engine is stopped by turning off the fuel or switching off the ignition. Note that the crankshaft revolves twice for every four strokes, and only one of those strokes produces power.

**Fig 1-6** The 4-Stroke Cycle

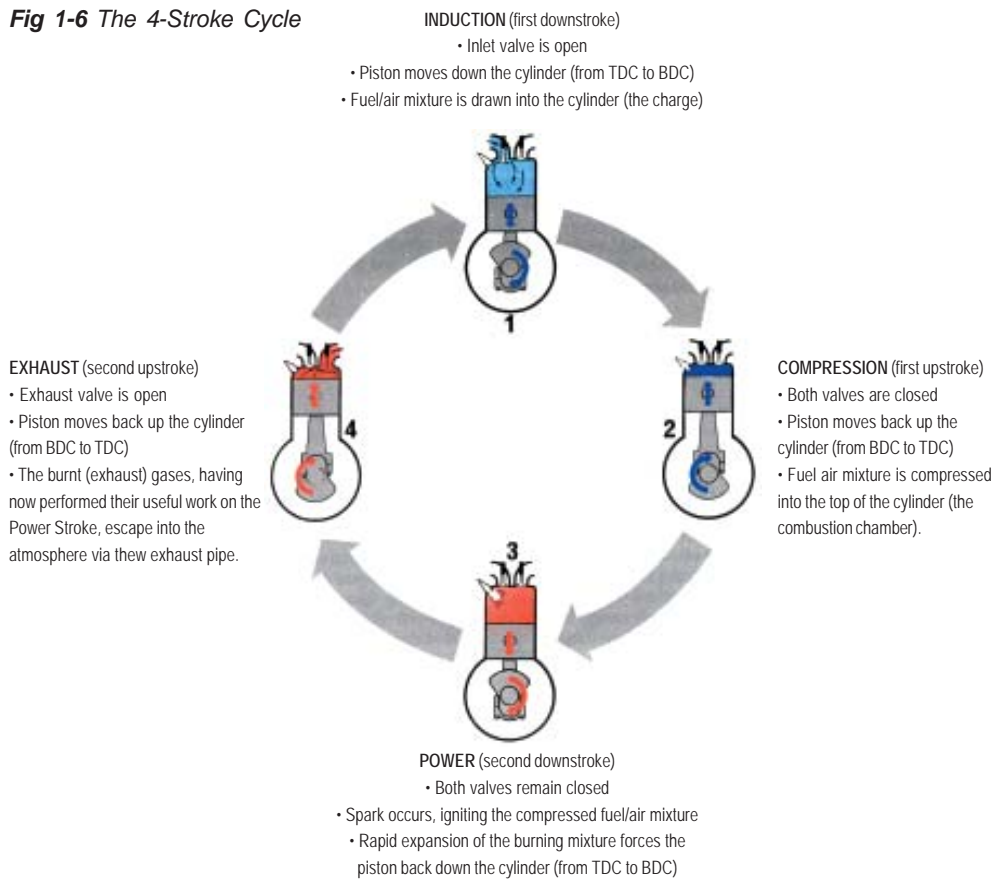

10. In the simple 4-stroke cycle at Fig 1-6 the valves open or close at either TDC or BDC; also, the ignition occurs at TDC on the compression stroke. In practice, an engine gives much more power and runs more efficiently if the valve and ignition operations occur when the crank is at slightly different positions. In this modified four stroke cycle:

- The inlet valve is opened before TDC and is not closed until after BDC.
- The exhaust valve is opened before BDC and is not closed until after TDC

- c. The charge is ignited before TDC on the compression stroke.
11. To describe the modified valve and ignition timings, the following terms are used:
- “Valve lead” means that the inlet valve opens before the piston has reached TDC, and that the exhaust valve opens before BDC.
  - “Valve lag” means that the inlet valve closes after the piston has passed BDC and that the exhaust valve closes after the piston has passed TDC.
  - “Valve overlap” means that both inlet and exhaust valves are open together. It is a period when the inlet valve opens before TDC and the exhaust valve does not close until after TDC (see Fig 1-7).

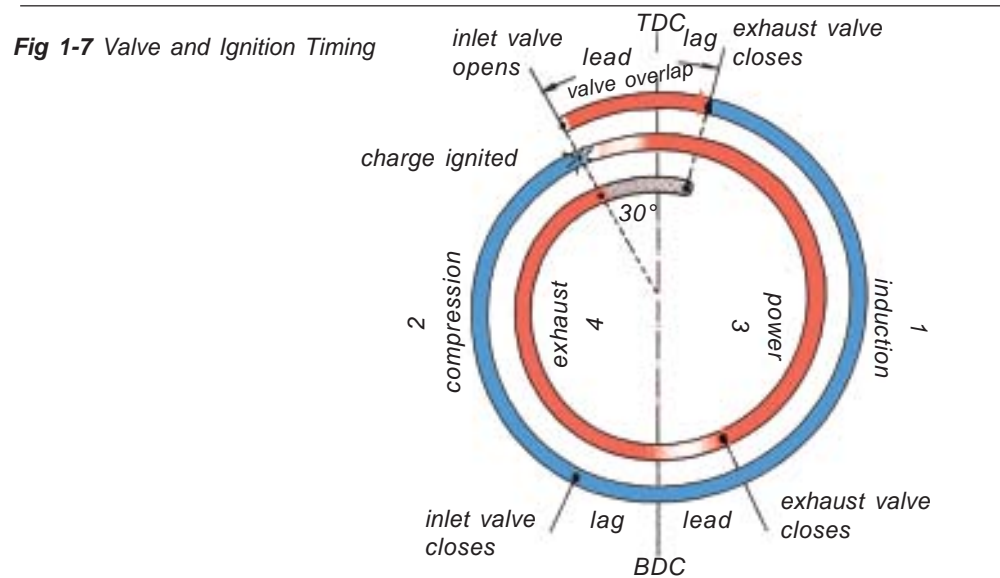

- “Ignition advance” describes the fact that ignition occurs before the piston reached TDC on the compression stroke.

(Note that timings of all these events (ie ignition, and the valves opening or closing) are all measured in degrees of crankshaft rotation - eg “120 before TDC” etc.)

12. Increasing the efficiency of the engine by using valve lead, lag and overlap is made possible by a natural feature of the piston engine called “ineffective crank angle”. This means that near TDC and BDC a fairly large rotation of the crankshaft causes only a small linear movement of the piston.
13. The valves are spring-loaded into the closed position and are opened

by a mechanism geared to the crankshaft. The one shown at Fig 1-4 is a camoperated pushrod, but there are other methods. The mechanism operates at half the crankshaft speed so that each valve opens and closes only once for each two revolutions of the crankshaft. As shown earlier the valves are timed to open and close at special positions of the crankshaft and piston, measured in degrees of crankshaft rotation. For example, in Fig 1-7 the inlet valve leads 300 before TDC and the exhaust valve lags 150 after TDC. The inlet valve lead ensures that the maximum charge of mixture enters the cylinder on the induction stroke, and the exhaust valve lag ensures maximum scavenging of the burnt gases on the exhaust stroke.

#### Other Essentials

14. There is much more to an engine than the piston, cylinder and crankshaft. Other vital parts include:

a. The Carburettor. The carburettor supplies the cylinder with thoroughly mixed fuel and air in the correct proportions. A fuel injector may be used for the same purpose. Both systems are described later.

b. The Ignition System. The ignition system ignites the mixture of fuel and air inside the engine cylinder at the correct point in the cycle. To do this a sparking plug in each cylinder is connected by high tension cables to a distributor. This is a device for distributing the high voltage electrical impulse from the magneto to each cylinder in correct sequence, where there is more than one cylinder. The magneto is driven, through gearing, by the crankshaft to ensure that the sparks occur at the correct point in the four-stroke cycle. In aero engines there are normally 2 spark plugs to a cylinder, with 2 magnetos, for improved combustion and added safety.

c. The Lubrication System. If moving metal parts of the engine are allowed to rub together the resulting friction causes heat, and the parts will tend to "seize" (weld together). The oil in the lubrication system provides a strong film between these moving parts, keeping them apart and greatly reducing friction (Fig 1-8). Oil is also used to assist in engine cooling, by conducting heat away from the cylinders as the oil is pumped around the engine.

**Fig 1-8 Lubrication**

*apparent smooth surface*

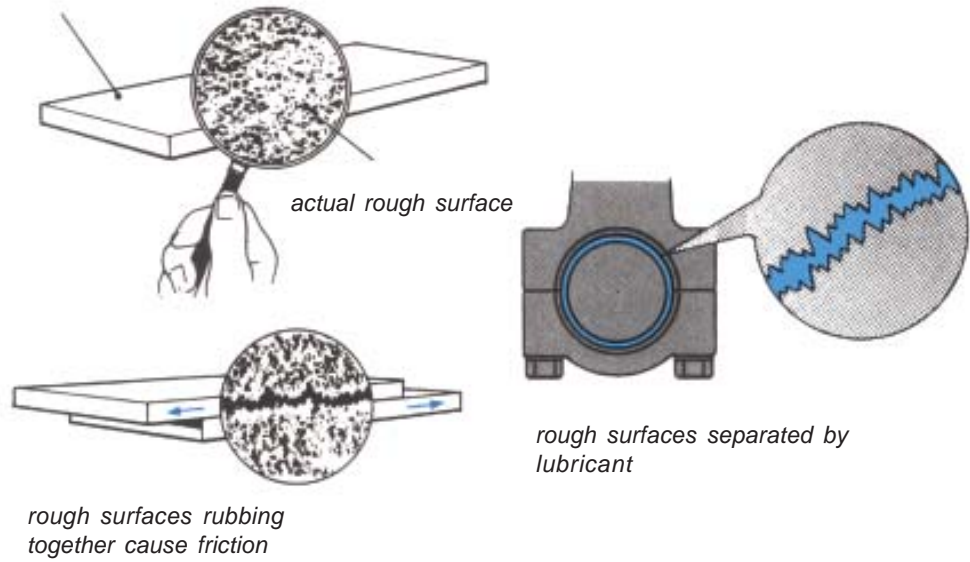

d. The Cooling System. The heat generated in combustion will exceed 2000 oC. Therefore engine materials in contact with the combustion flame require quick cooling. Special liquid and air cooling systems are designed to do this (Fig 1-9).

**Fig 1-9 Cooling System**

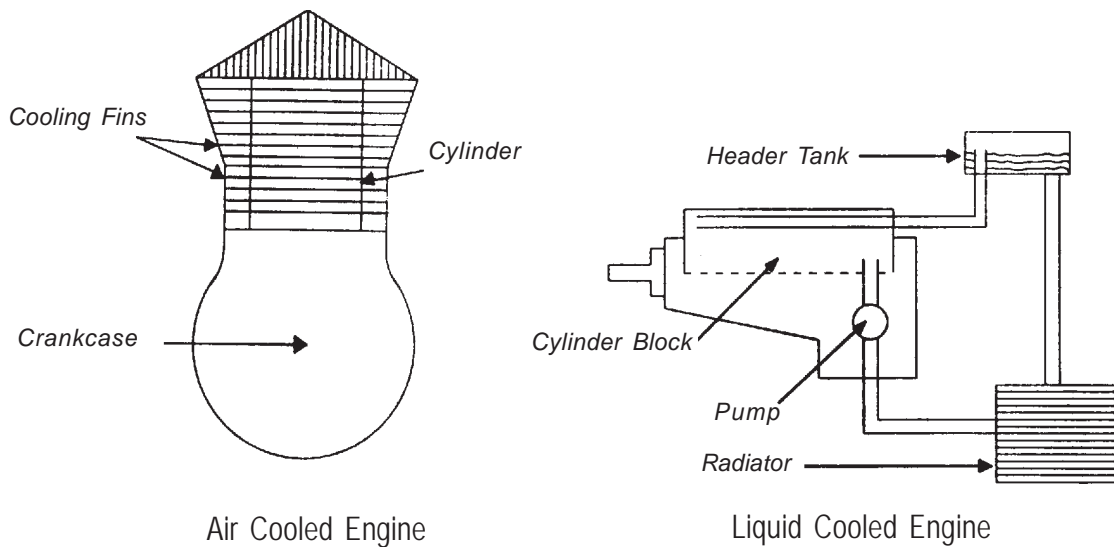

### The Multi-Cylinder Engine

15. Engines with more than one cylinder are used in aeroplanes, as single cylinder engines cannot provide enough power. Moreover, they tend to run roughly because the propeller receives only one power impulse from the crankshaft in every two crankshaft revolutions. A two-cylinder engine with its power strokes evenly spaced will provide one power stroke for each revolution of the crankshaft. One with four cylinders provides two power strokes per revolution, six cylinders provide three power strokes, and so on - and engines with twelve cylinders or more can provide smooth near-continuous power for the propeller.

## Self Assessment Questions

***Do not mark the paper in any way - write your answers on a separate piece of paper.***

1. How does an internal combustion engine obtain its power?
2. What happens to the temperature of the fuel/air mixture when it is compressed?
3. What ignites the fuel/air mixture?
4. Define TDC?
5. What is valve lag?
6. What is ineffective crank angle?

## CHAPTER 2

### CARBURATION

#### Introduction

1. The object of carburation is to provide the engine with a combustible mixture of air and fuel, in the right quantities. Air is freely available but fuel must be metered to control the mixture strength, and the supply of the mixture must be governable in order to control the power output. Both carburetors and fuel injectors meet these requirements. Carburetors were invented first, and are still used in many engines for cars and light aircraft, but fuel injectors are more efficient.

#### A Simple Carburettor

2. The essential components of a simple carburettor (Fig 2-1) are:

- a. The Air Intake and Choke Tube. Air from the atmosphere goes into the air intake and then into the "choke" tube, where the air passage narrows. To get through the narrow part, the air has to speed up - and its pressure therefore drops (remember Bernoulli's Theorem in "Principles of Flight"?). In particular, there is a reduction in air pressure round the main jet.

**Fig 2-1** A Simple Carburettor

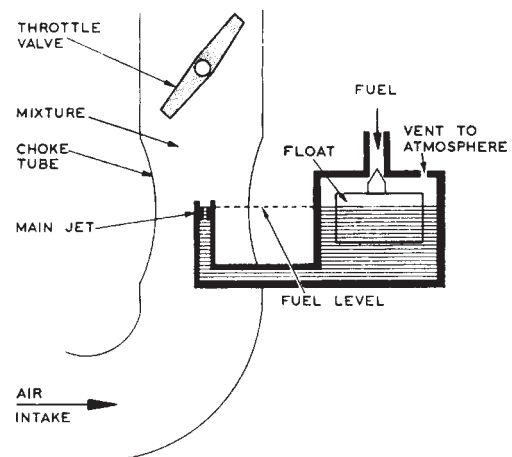

- b. Main Jet. The main jet is situated in the supply pipe from the float chamber to the throat of the choke tube. The reduced air pressure at the choke sucks fuel into the air flowing towards the cylinders. The main jet is actually a small hole, drilled to an exact size.

- c. The Float Chamber and the Float Mechanism. The float mechanism maintains the level of fuel in the carburettor and so keeps a constant pressure

of fuel at the jet. When the fuel level in the chamber falls because of the fuel flow to the engine the float also falls and allows more fuel to enter the chamber until, rising again, the float shuts off the supply. The float chamber is vented to atmosphere to equalize the air pressure above the fuel with that of the atmosphere; this allows fuel to flow freely to the main jet.

d. Throttle Valve. The throttle valve controls the flow of mixture into the engine. On the induction stroke, the piston creates a drop in pressure in the cylinder, and air from the air intake flows in. Only with the throttle valve fully open is there an unrestricted flow. At all other times the pressure in the air intake is held below atmospheric pressure by the throttle valve and the engine cylinder does not receive a full charge.

#### **Size of Fuel Jet**

3. Assume the engine is running with the throttle valve partly open, as in Fig 2-1. Air is flowing from the air intake to the engine cylinder. As the airflow passes through the choke tube, its speed increases and its pressure drops. This drop in air pressure at the main jet sucks fuel from the jet into the airstream. The rate of the flow depends on the degree of air pressure drop at the choke, as the fuel pressure reaching the jet is kept constant by the float chamber mechanism. Because the jet is of such a small size and the airflow (being disturbed by the action of the choke) is turbulent, the fuel issues from the jet as a spray and mixes freely with the air to form a fine mist. Further vaporization occurs in the induction passages as the mixture absorbs the heat of the cylinder head. The correct fuel to air ratio is assured by fitting a suitable sized jet.

4. Progressive opening of the throttle valve increases the flow of air through the choke and further reduces the pressure across the main jet. This increases the pressure differential between the float chamber and the jet, and more fuel flows through the jet to mix with the increased flow of air.

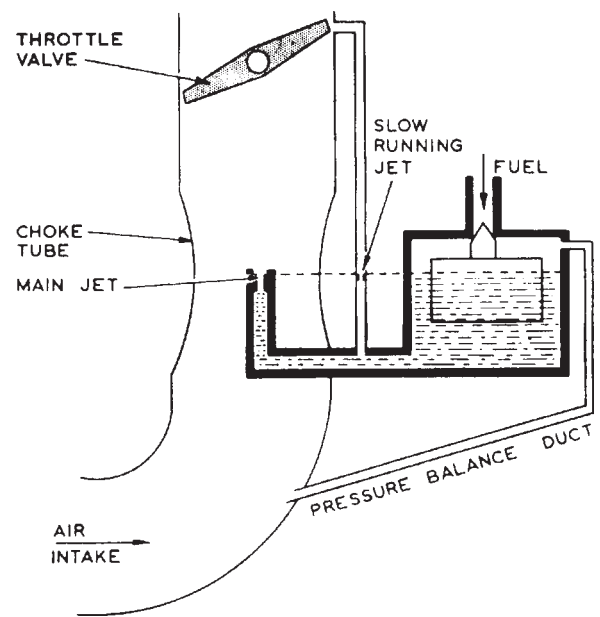

**Fig 2-2** *Slow Running*

5. When the engine is set to minimum power, we say "the throttle is closed". However, the engine would stop if the throttle valve were to be fully closed - so we design it to stay open slightly at the edge (see Fig 2-2). Even so, with the throttle valve in this position the main airflow through the choke becomes so slow that there is not enough pressure drop at the main jet to suck fuel through to keep the engine idling. However, there is some suction at the edge of the throttle valve where the slight gap has been left, so we feed some fuel to that gap. Fig 2-2 shows how a passage is made connecting the main air duct at this point to the fuel feed from the float chamber, and a "slow running jet" (smaller than the main jet) is fixed in the passage. Thus, when the throttle valve is "closed" to engine idling speed, fuel flow from the main jet almost ceases, but the drop in pressure then presented at the edges of the throttle valve is enough to produce the required flow from the slow running jet into the induction system.

#### Carburettor Refinements

6. So far we have discussed only a simple carburettor which, although workable, would not work well! Shortly we shall examine some features which improve the performance of all carburettors, and other features which apply particularly to aero engines. However, first we need to know more about the ratio of air to fuel that forms the mixture (or charge) that the carburettor supplies to the engine.

#### Air to Fuel Ratio

7. The actual ratio of air to fuel in the charge will vary from one type of piston

**Rich or Lean Mixtures**

engine to another. Moreover, the best ratio for efficiency and complete combustion also depends upon the chemical make-up of the particular fuel. However, a normal air to fuel ratio is 15 to one by weight (not by volume), for quite a wide range of piston engines. A mixture that has an excess of fuel is described as a "rich" mixture, whilst a "weak" or "lean" mixture has an excess of air. You may also see the term "mixture strength" instead of the rather cumbersome "air to fuel ratio".

8. The simple carburettor described earlier is too basic to provide the correct mixture at all power settings. It tends to give a progressively richer mixture, the more the throttle valve is opened. There are various refinements that can be added to the carburettor to overcome this problem. Two well-proven ones are:

- a. Partly blocking the main jet at higher engine speeds. This can be done gradually, by feeding a finely-tapered needle into the jet - first the needle point and then, as engine speed increases, more and more of the thicker part, thus gradually restricting the fuel flow to keep the mixture strength correct.
- b. "Diffuser" action, a system which allows extra air to "leak" into the choke with the fuel from the main jet when the engine speed increases. Two tubes are fitted round and above the jet (Fig 2-3). The inner tube is drilled along its length with a number of small holes of precise size and position.

**Fig 2-3 Diffuser Action**

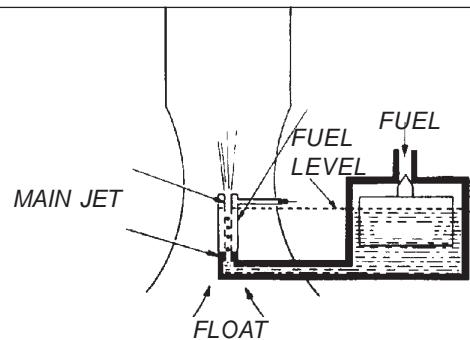

The outer tube has an air inlet port at its upper end. When the engine is running at low speeds, the fuel level is just below this air inlet port. The initial tendency for the mixture to richen as the throttle is opened is countered as soon as the fuel level falls and uncovers the first holes in the inner tube. This allows a controlled amount of air to enter above the jet and the diffuser to deliver a correct mixture of air and fuel. A progressive increase in engine speed, with its greater tendency to richness, merely uncovers more air holes to admit more air and restrict the fuel flow to that required to maintain the correct fuel to air ratio.

**Mixture Strength - How to Change**

9. There may be operating conditions where we wish to make the mixture lean or rich deliberately. For example, for economic use of fuel, a slightly weak mixture gives the best results, but the engine acceleration and general flexibility is then relatively poor and the maximum power available is reduced. A slightly rich mixture produces the highest power output from an engine and provides reasonable acceleration, but is uneconomic for long periods of running. For an aircraft engine it is important that aircrew should be able to change the mixture strength (within certain limits) to suit in-flight conditions - for example, a rich mixture for take-off or climbing, and a weak mixture for economical cruising. Several methods are available, including:

- a. Using a finely-tapered needle to partly block off the main jet when a lean mixture is needed, or to leave the jet fully open for a rich mixture. If a needle is already fitted as in para 8a above, the same needle can be used.
- b. Using 2 or more main jets in the carburettor and making one or more of them inoperative when economy is required.
- c. Fitting extra (or secondary) choke tubes, which are interconnected with the throttle operation, such that they work only when high power settings are selected.

Accelerator Pump

10. When a throttle valve is opened to accelerate an engine, the airflow from the intake immediately rises, but as fuel is so much heavier than air, fuel flow from the jet increases at a much lower rate. This causes a momentary weak mixture, or fuel lag, that slows down the engine's acceleration rate. On many small engines this is overcome by having the mixture set to a slightly "rich" figure throughout the throttle range. However, for fuel economy, especially with engines of larger power output which run for long periods at a steady speed, it is more usual to use a slightly "weak" mixture, and fit an "accelerator pump" which operates briefly whenever the throttle opening is increased. One type is a small plunger pump in the carburettor, connected to the throttle lever, and working on the same principle as an ordinary syringe. When the throttle mechanism is closed fuel is drawn up the plunger, and when it is opened the fuel is injected into the induction pipe. Thus, only when the throttle valve is opened is the extra fuel, needed for engine acceleration, delivered

into the induction pipe. At all other times the engine runs at an economical mixture strength.

### Direct Fuel Injection

11. Many modern piston aero engines use direct fuel injection in preference to a float chamber carburettor. A fuel injection engine has a normal air intake and throttle butterfly, but there is no choke in the intake. Fuel under high pressure is injected directly into the cylinder on the induction stroke. High pressure delivery through minute holes in the injector nozzle ensures complete vaporization of the fuel as it enters the cylinder. Special devices, in many cases computer-controlled, meter the amount of fuel injected to suit various throttle settings and to compensate for changes in altitude and forward speed. Engines fitted with fuel injection can operate when inverted (unlike carburettor engines) but the time and frequency of inverted flight may then be limited by the need to maintain adequate engine lubrication and cooling.

### Special Features of Piston Aero Engines

#### ***Problems of air supply***

12. A particular problem for aero engines is the fact that the engine's air supply gets thinner as the aircraft climbs. In the choke tube the thinner air will continue to provide suction which draws fuel out of the main jet, but the thinner air has less mass than at ground level, so unless some correction is made the mixture gets richer and richer as altitude is increased. Clearly, we need to reduce the amount of fuel coming through the main jet in proportion with the reduction in the mass (or density) of the air. One automatic method involves positioning a tapered needle attached to an aneroid capsule in the main jet system. As the aircraft climbs the aneroid expands in proportion to the decrease in air pressure and the needle, being attached to the aneroid, closes down the main jet in proportion, thus restricting fuel flow (Fig 2-4). However, reducing the fuel flow to match the reduced mass of the air supply also reduces the power available; for example, at 18,000 ft there is only about 50% of the sea-level power.

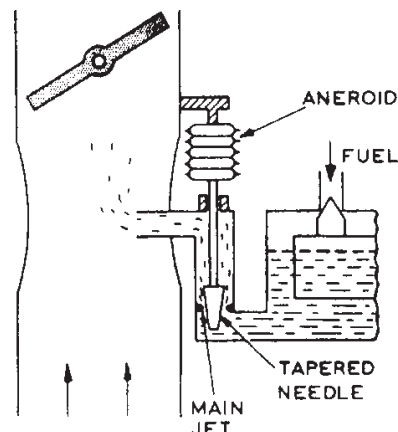
*Fig 2-4 Automatic Mixture Control*

### Supercharging

13. Sea level power can be obtained at altitude only if the sea-level weight of mixture can be supplied. This can be done by pumping mixture to the cylinders, rather than relying on the suction created by the piston. The solution is to fit a "supercharger" - a centrifugal pump, driven from the crankshaft - between the throttle valve and the engine cylinders (Fig 2-5). In fact, depending upon their size and design, many superchargers can pump the fuel/air mixture into the cylinders at a pressure that is much greater than sea-level. Thus, provided the engine is designed to withstand the extra pressure, we have a means not only of making the engine supply sea-level power at altitude, but also of increasing power well above that normally available at sea-level. Clearly, each type of engine will have a maximum "boost" that it can endure (boost is the pressure in the induction manifold, normally expressed in lbs per sq in, or inches of mercury, or millibars); consequently to protect the engine it is necessary to fit an automatic boost control. This measures manifold pressure and controls throttle valve movement to give the amount of boost that the pilot has set with his throttle lever. To avoid over-boosting the engine in certain conditions of flight, eg on take-off, the pilot's throttle lever(s) is 'gated'. In the last, fully developed large piston aero engines of World War II supercharging was able to increase and maintain engine power up to great heights by using 2-stage, 2-speed units, but such devices needed large inter-coolers (to reduce the temperature of the mixture, it having been heated significantly by compression - remember the bicycle pump) and are seldom found these days.

**Fig 2-5** A Simple Supercharger

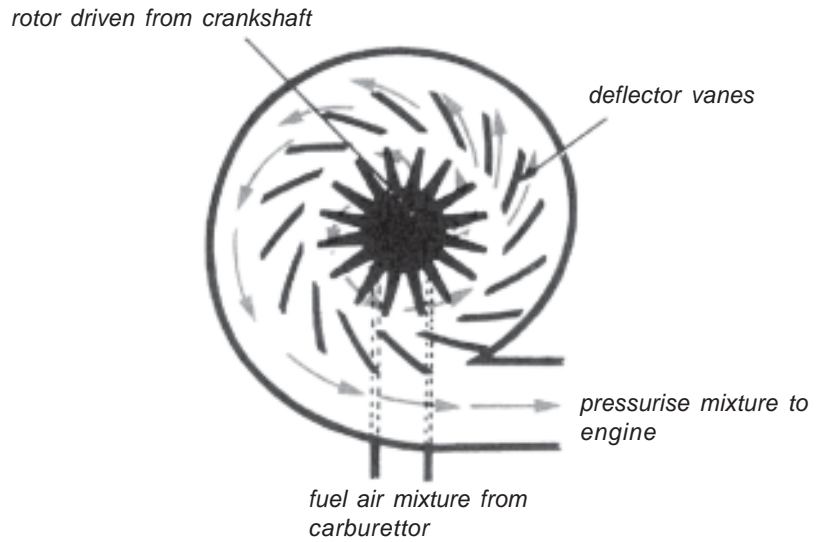

---

14. The modern piston aero engines fitted to the comparatively light aircraft which still use them today are seldom supercharged to the same extent as before, but many employ either a single-stage, single-speed supercharger or a turbo-charger (as do some modern car engines) to increase and/or maintain manifold pressure. The turbo-charger operates in much the same way as a supercharger but because it is driven by exhaust gases and not directly driven by the engine it cannot increase or maintain power to the same extent as a supercharger. The exhaust turbo-charger requires high engine speeds (rpm) to be effective and there is some lag after the throttle is opened whilst the exhaust gases speed up the impeller.

## Self Assessment Questions

***Do not mark the paper in any way - write your answers on a separate piece of paper.***

1. What is the best fuel/air ratio for correct mixture?
2. What are the two main functions of a carburettor?
3. Give three essential components of a float chamber type carburettor?
4. How does the float chamber mechanism maintain the correct fuel pressure at the jet?
5. What governs the amount of fuel passing through the main jet?
6. What happens if the pressure differential between the float chamber and the jet is increased?
7. Give two common methods of varying the mixture strength?
8. How does a supercharger work?
9. What is a boost control?
10. What is a turbo-charger?

# CHAPTER 3

## IGNITION - PISTON ENGINE

### Introduction

#### **How we get ignition**

1. We have already explained how the 4-stroke engine operates and how, just prior to the power stroke, the compressed mixture of fuel and air is fired by an electric spark. To produce this spark, some form of electrical energy is required. Car manufacturers use a comparatively cheap and simple method, in the form of a battery and high tension coil. Because of the need for great reliability in aero engines magnetos are preferred.

### The Magneto

2. In essence, a magneto is a small dynamo that generates a low voltage current which it then transforms into a series of very high voltage impulses. Each impulse is fed to a sparking plug screwed into the cylinder head, and produces a high temperature spark across the earth and central electrodes of the plug. It is driven by the engine's crankshaft.

3. Aero engines have dual ignition, ie 2 complete but entirely independent ignition systems. This provides safety (the engine will still work if one system fails) and it improves the engine power (if the charge is ignited by 2 plugs it burns quicker and more efficiently).

4. The essential components of a magneto are:

a. The permanent magneto system, which provides the necessary magnetic field to induce a current into the primary winding.

b. The armature, which consists of the primary and secondary windings, both wound round a soft iron core.

#### **Contact Breaker**

c. The contact breaker, a mechanically operated switch, timed to break the primary circuit when the current flow is at its maximum. The contact breaker setting (gap) is important. Any variation from designed size of the gap has the effect of altering the internal timing of the magneto and the ignition timing. Thus an incorrect setting produces a weak spark at the wrong time and adversely affects engine performance.



d. The capacitor (condenser) which reduces burning or pitting of the contact breaker points during the "make and break" action. It also causes the primary current to fall to zero more quickly and thus ensures a faster collapse of the magnetic field. The faster this collapses, the greater is the current induced in the secondary coil, and hence the stronger the spark at the plugs.

e. The distributor which directs the secondary or high tension current to each sparking plug in the correct sequence.

**Fig 3-1** Rotating Magento Showing Flux Changes

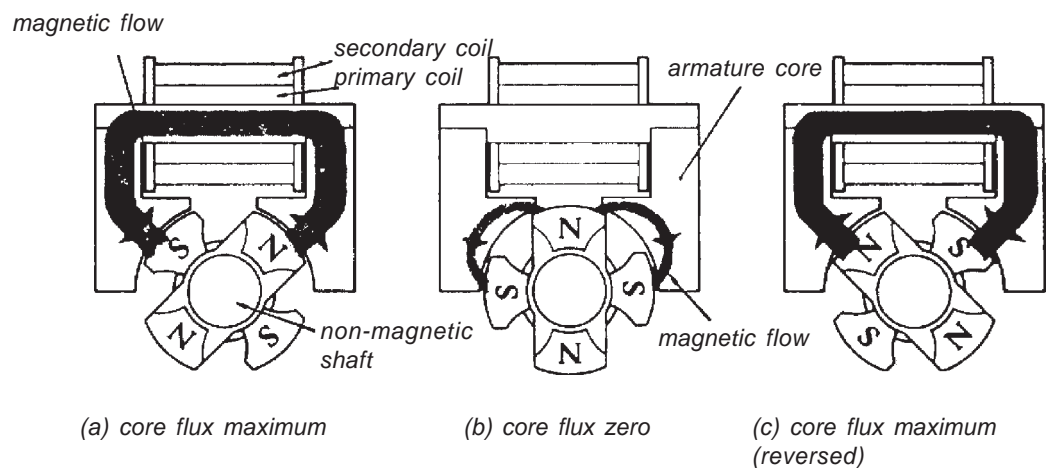

5. The permanent magnet system is a tubular magnet, which has its poles extended to form 4 separate magnetic poles - 2 north and 2 south. It is mounted on a non-magnetic shaft. The shaft is so positioned that it rotates between the soft iron extensions of the armature core. From Fig 3-1 you can see that as the shaft rotates, so the magnetic flux through the armature reverses, causing the magnetic lines of force to cut across the primary winding. When a magnetic field is moved so that the lines of force cut across an electric conductor, an electromotive force is induced in the conductor. Therefore, as long as the shaft and magnet are rotating, an electromotive force is being generated in the primary winding. The strength of the electromotive force depends on the speed of rotation and the strength of the magnet.

**Fig 3-2 Primary Circuit**

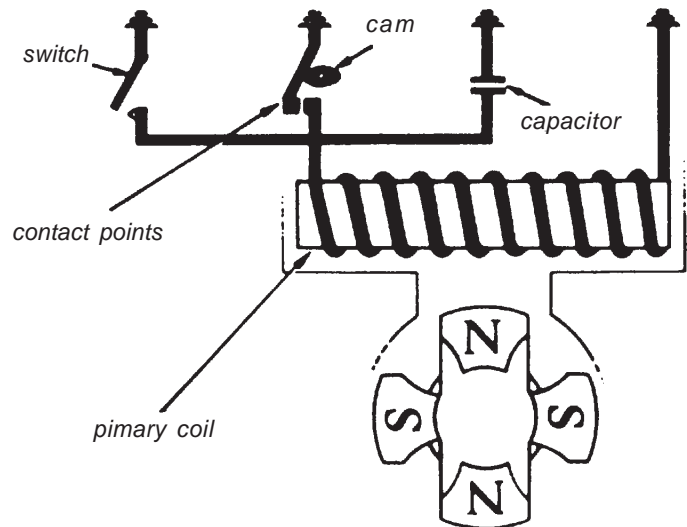

6. The primary winding, together with the contact breaker and capacitor, form part of the primary circuit (Fig 3-2). With the switch open (as shown) and the contact breaker points closed, a current will flow in the primary circuit while the magnet system is rotating. This current is too weak to produce a spark at the sparking plugs: but it is strong enough to produce a magnetic field round the primary winding. A secondary winding is wound round the primary winding and lies within the influence of the magnetic field of the primary circuit. This secondary winding is connected through the distributor to the sparking plugs (Fig 3-3).

**Fig 3-3 Simplified Complete Magneto Circuit**

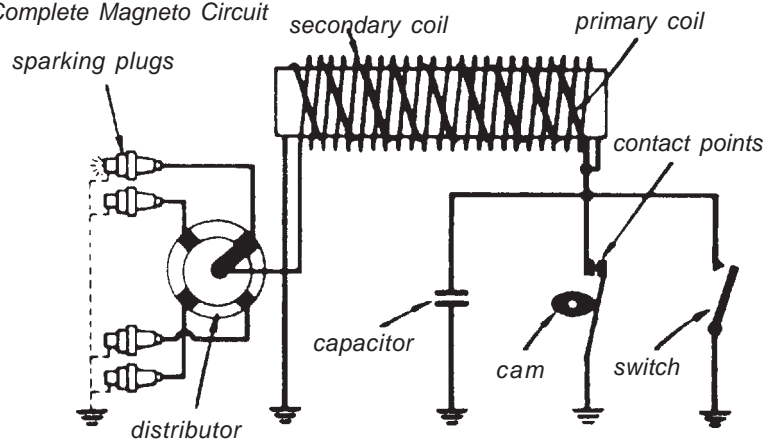

7. To produce a high voltage current which is enough to cause a spark at the sparking plug points, we need to open the contact breaker points - whereupon the current stops flowing in the primary circuit; this in turn causes the primary winding magnetic field to collapse and cut across the many turns of the secondary winding.

This collapse immediately induces a high voltage current in the secondary winding, sufficient to produce a spark at the plug points. In practice the contact breaker is operated only when the current in the primary circuit is at its maximum, and this occurs 4 times in each revolution of the rotating magnet.

### The Distributor

8. The distributor consists of a rotor turning at half engine speed (on a 4- stroke engine) inside a circular cover. The cover has as many brass segments symmetrically placed round the inside of the cover as there are cylinders. The current from the secondary winding is fed to the rotor and in turn to the appropriate brass segment to feed the sparking plug. The firing order to the cylinders is arranged to even the load along the crankshaft. For instance on a 4 cylinder engine, the firing order is usually, starting from the front cylinder, 1, 3, 4, 2.

### Sparking Plugs

9. Basically, a sparking plug consists of 2 electrodes set to form a gap. The high voltage current from the secondary winding jumps over the gap to create a spark. An aero engine sparking plug is made in 3 main parts (Fig 3-4):

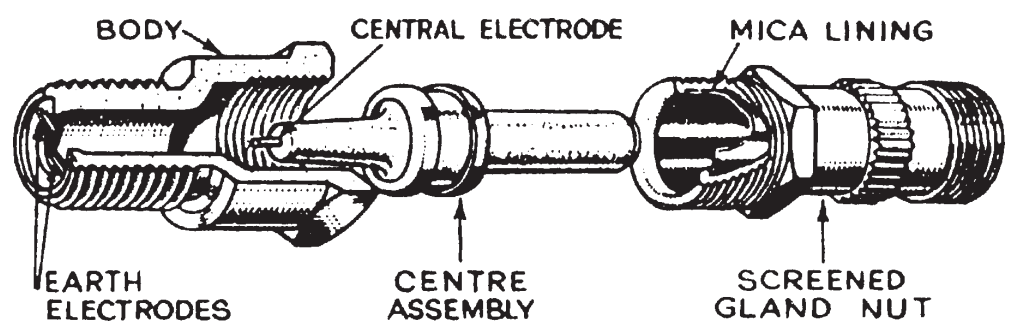

a. A hollow steel body which screws into the cylinder. The lower end of the body carries the earth electrodes.

b. A centre assembly, comprising the central electrode and its insulation. A soft metal washer is fitted between the central electrode and the body to make the join gas-tight.

c. A hollow steel gland nut that holds the body and central electrode together and also forms the screen against radio interference.

10. A sparking plug is subjected to intense heat, highly corrosive gases and a high electrical voltage. To withstand these stresses, many different materials are used in its manufacture. For example, the central electrode is made from nickel rod with a silver insert; the centre insulation is usually ceramic, a form of pottery; platinum is usually used for earth electrodes. The constant sparking across the electrodes is a form of arcing which can wear away the metal of the electrodes. This erosion can be reduced by fitting an electrical resistor within the plug.

11. Each type of engine requires a type of plug that is specifically designed for it, so it is important that only the approved type is fitted. Periodically, the plugs are removed from the engine, cleaned, the insulation properties checked, and the gaps between the central electrode and the earth electrodes adjusted for size. This latter action is necessary because:

a. Erosion at the electrodes eventually increases the gap.

b. The strength of the spark across the electrodes is best when the gap is a particular size (NB - each type of plug has a recommended gap setting for best performance).

## Self Assessment Questions

***Do not mark the paper  
in any way - write your  
answers on a separate  
piece of paper.***

1. Why do all aero-engines have dual ignition systems?
2. What is the effect of an incorrect contact breaker gap?
3. What is the purpose of the capacitor?
4. What governs the strength of the electromotive force?
5. How is the high voltage current required to provide a spark at the plugs produced?

# CHAPTER 4

## LUBRICATION AND COOLING - PISTON ENGINES

### Introduction

#### ***Why we lubricate***

1. Lubrication is a way of reducing the friction and wear between 2 sliding surfaces. Friction is the resistance that has to be overcome to allow movement between sliding surfaces. Wear is the loss of material resulting from the 2 surfaces sliding together. Any substance placed between 2 moving surfaces to reduce friction is a lubricant.

### Lubrication

2. When a lubricant is used, a thin but measurable film of it stays between 2 surfaces, preventing contact. The film works in 3 distinct layers, the outer layers clinging to the separate surfaces and the central layer moving between them. The thinner the lubricant, the more easily does this movement take place. The thicker (or more viscous) the lubricant, the greater is the force required to move one surface over the other.

### Properties of a Lubricant

3. The properties demanded from a lubricant vary considerably with the particular application. A lubricant for a watch is not suitable for either a bicycle or a steam engine; the load and working temperature vary in each instance. In general, a lubricating oil for an aero engine should be of a suitable viscosity for maximum loads and also retain this viscosity over the full range of engine temperature.

### An Engine Lubrication System

4. The internal moving parts of a piston type aero engine are lubricated by oil circulated from a tank. The oil is circulated through the engine and back again to the tank by engine-driven oil pumps. Far more oil is circulated than is needed to reduce friction alone; the extra flow is used to cool the internal components of the engine, eg bearings, undersides of pistons, gears etc (Fig 4-1 overleaf).

5. Oil is delivered through a filter to the engine pump which feeds the oil under pressure through internal ducts, hollow shafts and pipes to the bearings throughout

the engine. Most engines have the oil delivered to the bearings at a fairly high pressure (around 60 lb/sq in or 4.5 kg/sq cm), which not only strengthens the oil film against the bearing load, but also produces the rate of flow required through the small bearing clearances.

**Fig 4-1** Lubrication System

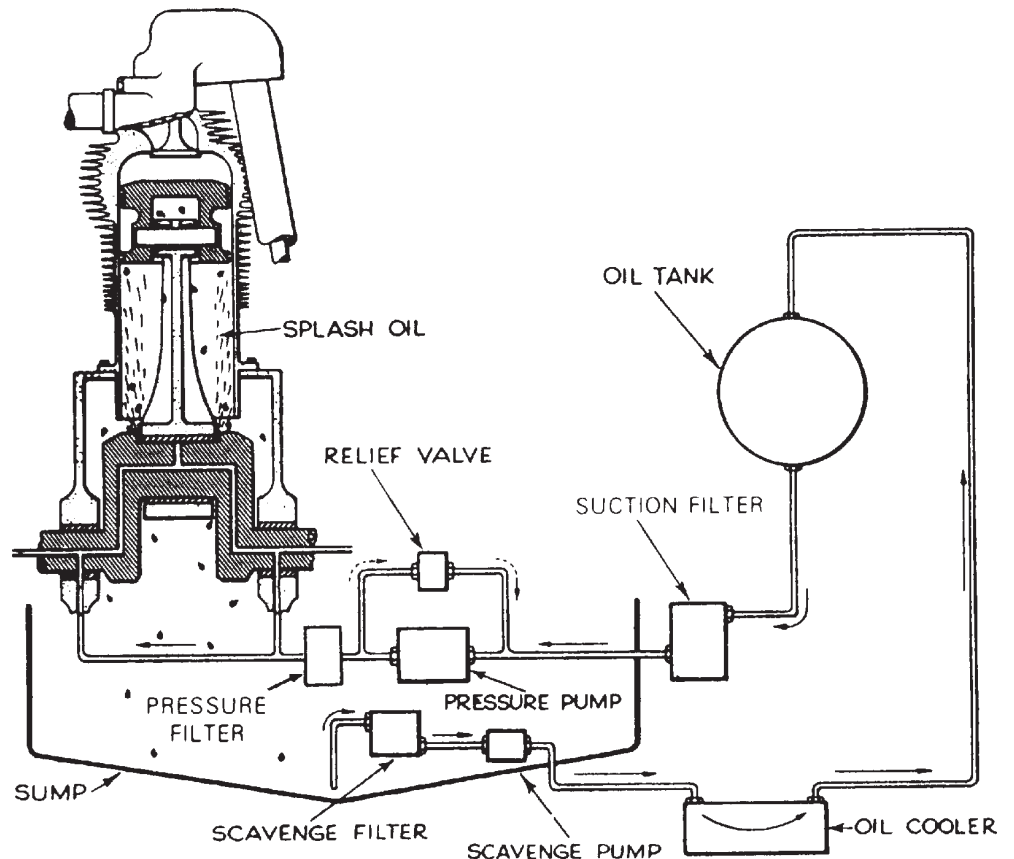

#### **Splash - Lubricates**

6. Oil escaping from the plan bearings 'splash-lubricates' the ball and roller bearings, gear teeth, piston rings, cylinder walls and other moving parts, and then drains to the sump or well at the bottom of the crankcase. More specific lubrication may be supplied by jets of oil directed on to the particular contacting faces from holes drilled in a nearby duct.

7. As the drain oil collects in the sump, it is drawn through a second filter by a scavenge pump and is returned, through an oil cooler, to the tank. The oil cooler dissipates the excess heat absorbed by the oil during its passage through the engine.

### Oil Pump

8. A "spur" gear pump is the common type for both pressure and scavenge pumps. It consists of 2 deep toothed spur gears working in a close fitting casing. Oil is carried round the casing in the space between the teeth in a somewhat similar manner to an endless bucket and chain, the meshing teeth and the small clearances in the pump preventing the oil returning to the inlet side (Fig 4-2).

**Fig 4-2** Spur Gear Pump

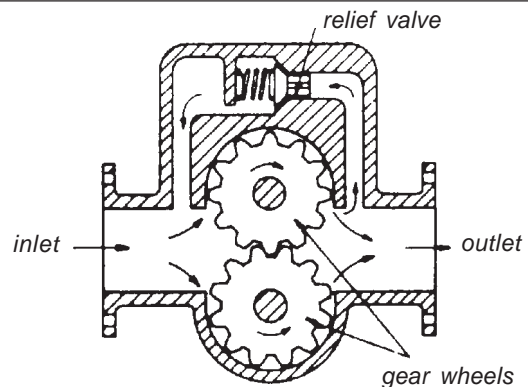

9. Of necessity, the pressure pump must be designed to give enough oil flow to maintain oil pressure when the engine is running at idling speed. Consequently, with an increase in engine speed, the increased flow tends to cause a dangerously high oil pressure. To prevent this, a relief valve is fitted between the outlet and the inlet ducts of the pump. The valve is normally closed, but when it senses that the oil pressure has reached the maximum allowed for that engine, it opens and the pressure drops. The excess oil is fed back to the oil tank without going through the engine. The scavenge pump is always made with a greater capacity than the pressure pump. This ensures that oil which has drained into the sump while the engine has been standing idle is returned to the tank immediately the engine starts.

10. If the total heat produced in a piston engine, about 50% is used as work energy and about 40% passes into the atmosphere through the exhaust pipe. The remaining 10% is absorbed by the pistons, cylinder heads, valves etc and by the circulating lubricating oil that splashes against them. Consequently, unless these components are cooled by some means, they become over-heated, causing distortion, increased wear, and a reduction in strength. Excessive temperatures may also cause the oil film to break down and result in engine seizure. Two methods of cooling are in common use; air cooling, and liquid cooling. Two everyday examples are motor cycles and cars.



### Air Cooling

11. In air-cooled engines the outer surfaces of the cylinder head and barrel are extensively finned and a flow of air is directed over the exposed surfaces. The fins are kept thin and close together to obtain a maximum surface in contact with the air. Deflectors, which include baffles, cowlings and gills, may be fitted to redirect the air to shrouded or shielded areas (Fig 4-3).

**Fig 4-3** Air Cooling System

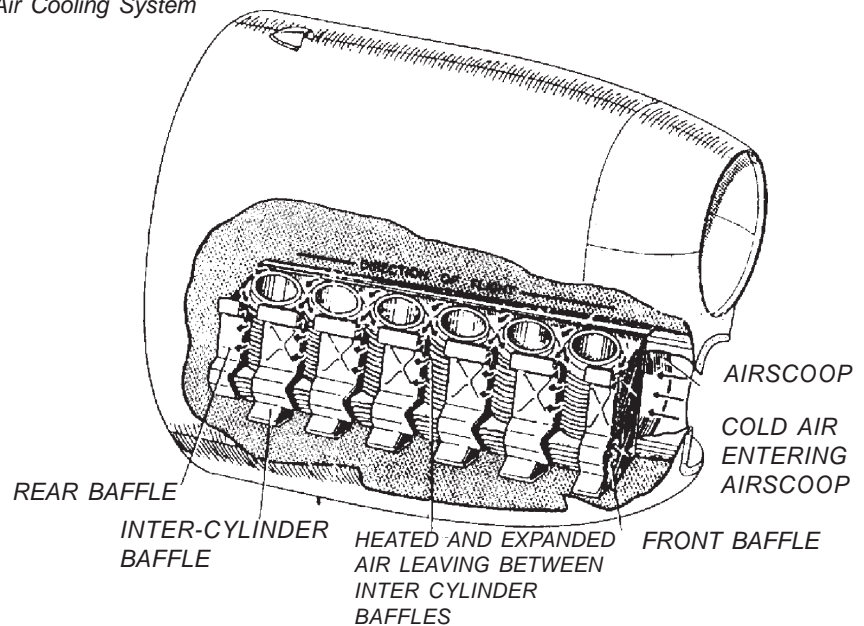

12. Air cooling is light, relatively cheap and little or no maintenance is required as there are few working parts. Air cooling, however, cannot keep the engine at a constant temperature under all conditions of forward speed, power and air temperature. Consequently, although reliable, the engine components tend to have a shorter life than those of a liquid-cooled motor.

### Liquid Cooling

13. There are few aircraft currently fitted with liquid-cooled engines, but liquid cooling is used extensively in cars. In liquid-cooled engines, the cylinders and cylinder head are double walled, or 'jacketed' and a liquid is circulated through the jackets. The basic coolant is water, but because of the lower temperatures at altitude, the addition of an anti-freeze agent is essential with aero engines and a mixture of 70% water and 30% ethylene glycol is normally used

14. It is equally important that the coolant should not be allowed to boil - and a particular problem for aero engines is that the boiling point of a liquid becomes lower and lower as the altitude increases, due to the lower atmospheric pressure. Thus the engine would be held at a lower - and less efficient - operating temperature, and (even worse) the coolant would boil off and be lost. After that the engine would rapidly overheat and "seize up". The solution is to pressurize the system so that the coolant is not exposed to low atmospheric pressure at altitude. All aero engine liquid coolant systems are therefore pressurized (as indeed are most modern motor car systems, although not to the same pressure as aircraft engine systems) and the system is sealed. This allows pressure to be built up to the extent that it actually raises the boiling point of the coolant, which enables the engine to operate at a higher temperature, and hence more efficiently. Of course there is always a safety relief valve in the system, to relieve the internal pressure if it goes too high.

#### Comparison

15. Liquid cooling systems are more costly than air cooling and they need more maintenance. However, they hold the various parts of the engine at a more even temperature, and they keep the operating temperature of the whole engine within a narrower range. Consequently, a liquid cooled engine normally has a longer life between overhauls than one with an air cooling system, and it is more efficient. Further, liquid cooled engines can be more easily streamlined and thus produce less drag on the aircraft.

## Self Assessment Questions

***Do not mark the paper in any way - write your answers on a separate piece of paper.***

1. What is friction?
2. Are all lubricants the same?
3. What are the two essential properties required of a lubricating oil for use in piston aero-engines?
4. What is the purpose of "splash oil" in an engine?
5. Why is a pressure relief valve necessary in an oil system?
6. Give the main disadvantage of air cooling as opposed to liquid cooling?
7. Why is a liquid cooling system pressurised?

## CHAPTER 5

### PROPELLERS

#### Introduction

#### **How a Propeller works**

1. A propeller consists of 2 or more blades mounted on a hub (Fig 5-1). The hub fits onto "propeller shaft", which supplies engine power to make the propeller rotate. The purpose of the propeller is to convert the torque (a rotational force) delivered from the engine into thrust (a linear force) which will propel the aircraft through the air. Each propeller blade is an aerofoil - that is, a cross-section of a blade is the same shape as the cross-section of a wing. Therefore, when a propeller blade is spun through the air by the propeller shaft, an aerodynamic lift force is generated on the blade - except that in the case of the propeller we call the force thrust, not lift. However, the airflow over a propeller is more complicated than that over a wing, so let us examine propeller airflow one step at a time.

**Fig 5-1** Four-bladed Propeller

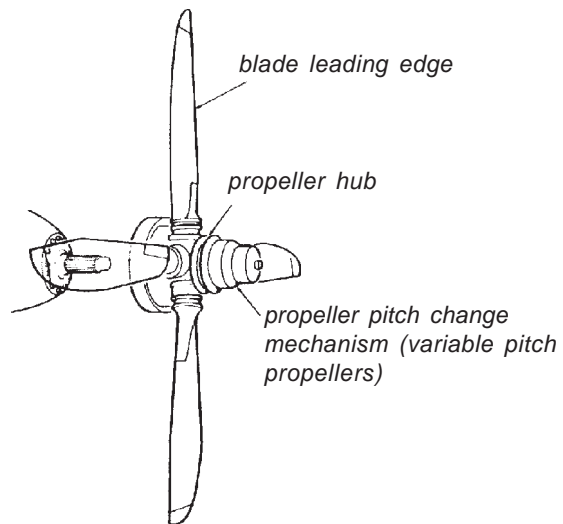

2. For the moment, consider just one blade section on one propeller blade (Fig 5-2). First, note that the chord line of the blade section makes an angle (the "blade angle") with a line drawn at 90° to the hub. Next, picture the propeller rotating on an aircraft that is stationary on the ground; the blade section will slice the air in a constant circle, and at each point in that circle it will meet the air at an angle of attack equal to the blade angle. Provided this angle is in the lift-generating range (ideally a small positive angle, and certainly not more than the stalling angle) our blade section will generate thrust.

**Fig 5-2 A Blade Section**

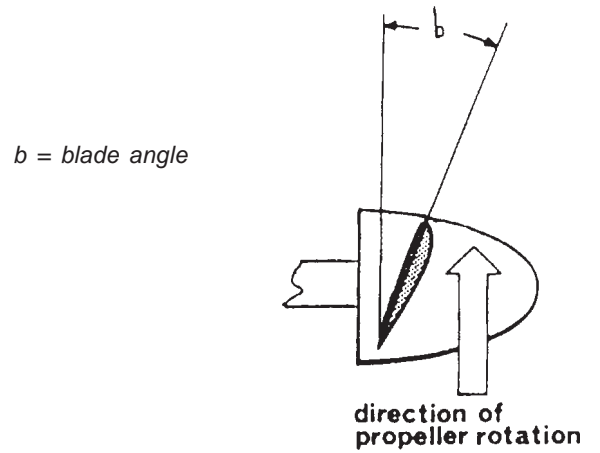

3. Now picture the same aircraft cruising straight and level. The propeller no longer slices through a constant circle.

**Fig 5-3 Helical Path**

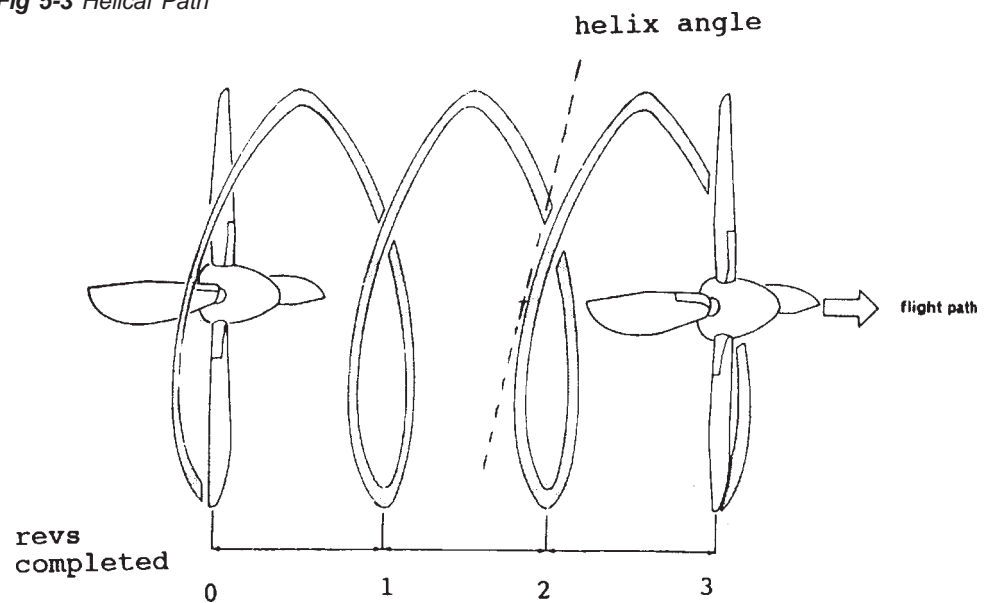

Instead, it follows a helical path as in Fig 5-3. This means that the angle at which our blade section meets the air is now influenced by the steepness of the helix (the helix angle). The helix angle actually reduces the angle at which the blade section meets the air - thus the angle of attack is now the blade angle minus the helix angle (Fig 5-4).

**Fig 5-4** Angle of Attack = Blade Angle minus Helix Angle

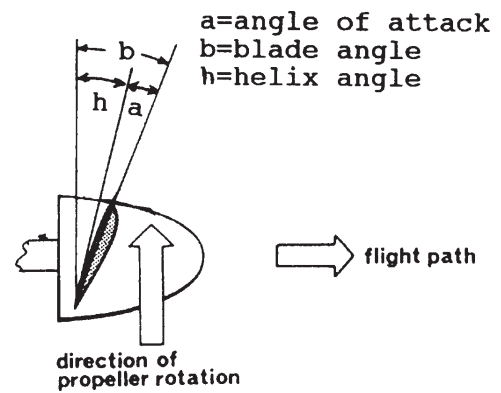

4. If, by a coincidence, the helix angle equals the blade angle, the angle of attack will be zero and the propeller will generate no thrust. Therefore, the propeller designer must ensure that the blade is set in the hub at a sufficient angle to allow for this. However, this task is complicated by the fact that the steepness of the helix is not a constant. Look at Fig 5-3 and mentally double the aircraft's forward speed, without increasing the propeller's rotational speed. The propeller will cover the same horizontal distance in only 1\_ propeller revolutions instead of 3, hence the helix angle will be much increased. In other words the helix will be stretched along sideways, like a coil spring when it is stretched - and the angle of the helix will be much steeper. The same effect would follow if, instead of doubling the forwardspeed the propeller was made to rotate at only half the number of revolutions per minute (rpm). Thus, the helix angle depends upon both the forward speed and the rpm of the propeller. A higher forward speed, or a lower rpm (or both) will increase the helix angle; conversely, a lower forward speed, or a higher rpm (or both) will decrease the helix angle. As you know, there is only a small range of angles of attack at which an aerofoil section can produce lift - about 1o to 15o - so the fact that the blade's angle of attack depends so much on a variable quantity (the helix angle), means that there is only a limited range of forward speeds and rpm that can be used. Namely, only forward speeds and rpm that give a helix angle such that "Blade Angle minus Helix Angle" is between 1o to 15o can be used. The solution is to find some means of altering the blade angle in flight. We shall look at this shortly, but first there is one more problem for the designer.

5. Imagine the aircraft cruising with a propeller that has a fixed blade angle.

A blade section near the tip of the propeller will follow a larger diameter helix than one at the hub - and its helix angle will therefore be smaller. Consequently, its angle of attack (blade angle minus helix angle) will be larger than one at the hub. By the same reasoning it is clear that the angles of attack for a series of blade sections, starting at the root and moving towards the tip, will increase progressively as you move towards the tip. This raises 2 major problems. Firstly, the angle of attack at the tip might reach the stalling angle, hence there would be no thrust and a huge drag penalty at that part of the propeller. Secondly, with all the blade sections operating at different angles of attack, only a small part of the propeller could be operating at an efficient angle of attack. The solution is to vary the blade angle progressively from root to tip. In fact, this has been common practice since the days of the Wright brothers, and all propeller blades now have a twist in them to give a large blade angle (called a "coarse" angle) at the root, and a progressively smaller blade angle (a "fine" angle) towards the tip (Fig 5-5). This "blade twist" allows the blade to maintain an efficient angle of attack along the full length of the propeller blade.

**Fig 5-5** Blade Twist

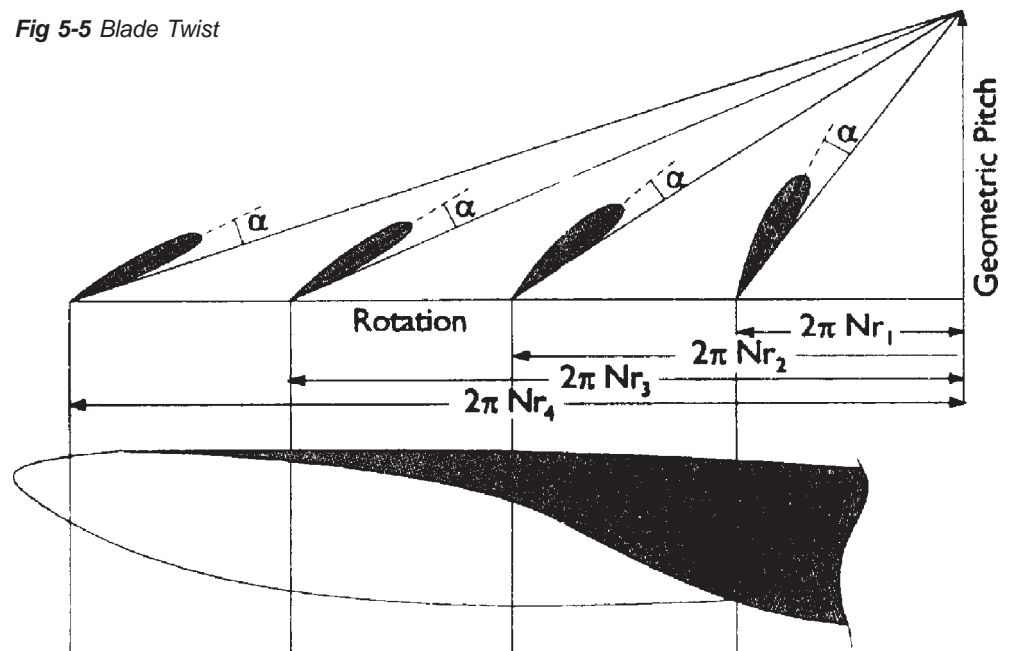

6. Thus far we have assumed that propeller blades are set into the hub at a fixed blade angle with no means of alteration during flight. This is so in the case of many small, light aircraft, but it does limit the efficiency of the propeller, particularly at higher forward speeds. We have already seen that as forward speed increases the helix angle of the propeller path also increases, hence the blade's angle of attack (blade angle minus helix angle) decreases. Clearly, at some high forward speed, the angle of attack will approach the zero lift figure, and thrust will reduce to zero - just what is not wanted at very high speeds! Conversely, at lower speeds the angle of attack will increase and so will the thrust (as long as the angle of attack is not so high that the blade stalls). However, a combination of high thrust and low forward speed is inefficient in terms of engine power needed (to counter the extra rotational drag that is generated on the propeller along with the high thrust), fuel used and distance flown. Clearly, between these extremes there will be just one speed at which the propeller is operating at its optimum angle of attack, and hence is at its most efficient. All these limitations can be overcome if we have some means of varying, in flight, the angle at which the propeller is set into the hub.

### **Pitch**

7. The term used for the blade angle in this context is "pitch". A "fixed-pitch propeller" is one whose blade angle at the hub cannot be changed. A "variable-pitch propeller" is one whose pitch can be changed in flight. "Coarse pitch" is when the blade pitch angle is at the highest angle in its designed range, and "fine pitch" is when the angle is at its smallest. With fixed-pitch propellers, the pitch angle chosen is usually that which suits the normal top speed of the aircraft. If the designer were to choose a pitch angle more suited to a lower speed, it would be too fine for the top speed range - and if the pilot were to feed a little extra power to the propeller, it might easily overspeed and damage the engine. Fixed-pitch propellers are, however, relatively cheap and they are well suited to light aircraft fitted with low-powered piston engines. Changes in thrust for different flight conditions - take-off, climb, cruise, descent etc - are regulated by the engine throttle control, which changes engine rpm (and hence propeller rpm).

8. With variable-pitch propellers, the engine and propeller combination is allowed to run at selected, efficient rpm throughout a wide range of flight conditions. Changes in thrust are selected by varying the propeller's pitch angle. For example, if more thrust is needed, the pitch angle is coarsened (ie increased) and at the same



time engine power is increased by feeding more fuel to it (ie opening the throttle). The engine/propeller speed is kept at its pre-selected value by the constant speed unit (CSU), described in the next paragraph. When the pitch and the engine power are increased to make the propeller produce more thrust, the coarser angle also makes the propeller produce more rotational drag - ie torque. This is why part of the action to get more thrust is to increase the engine power, so the engine can produce more torque to counter that from the propeller. The torque is measured and displayed in the cockpit, where it is used to assess the performance of the power plant (Fig 5-6)

**Fig 5-6** Torque Meter and Cockpit Gauge

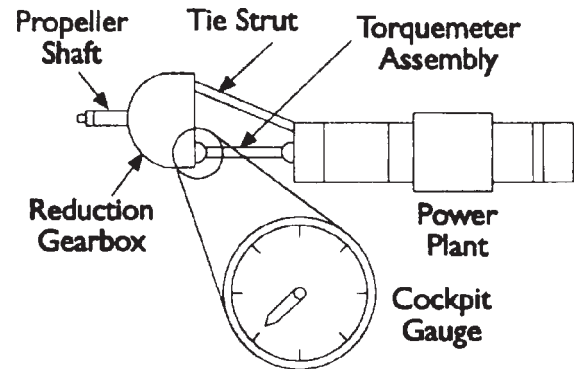

CSU

9. The CSU (Fig 5-7) senses changes in engine speed by means of a flyweight governor driven by the engine gearbox. The governor controls a servo system which feeds engine oil pressure to a piston. The piston alters the propeller pitch through cams and bevel gears, which change the piston's linear motion to the rotation needed to coarsen or fine the pitch of each blade.

**Fig 5-7** CSU and Pitch Change Mechanism

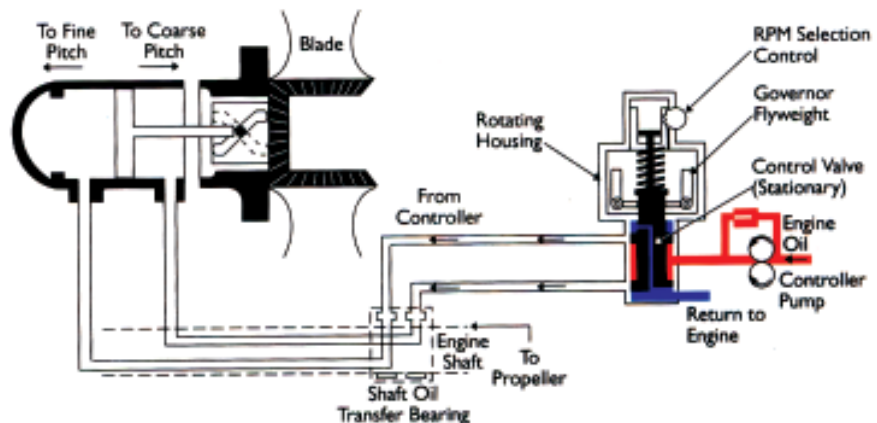

10. When the engine speed falls below the set rpm, the governor fly-weights open a valve allowing the oil to flow to the rear of the piston, thereby moving the piston to the left and fining the propeller (see Fig 5-8a). As the rpm recovers the fly-weights resume their balanced position closing the valve and hydraulically locking the propeller in the desired position (Fig 5-8b). If the engine overspeeds the fly-weights open the valve to coarsen the propeller pitch until the rpm is again restored with the fly-weights in the balanced position (Fig 5-8c).

*Fig 5-8a Engine Underspeed Correction*

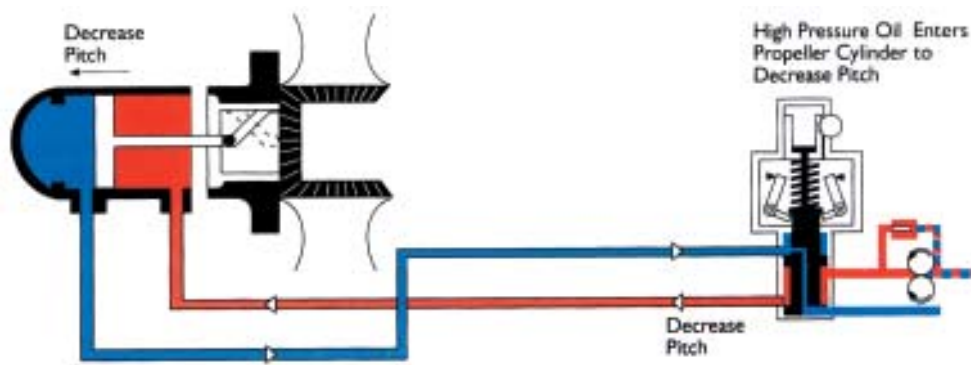

*Fig 5-8b Engine Speed Correct*

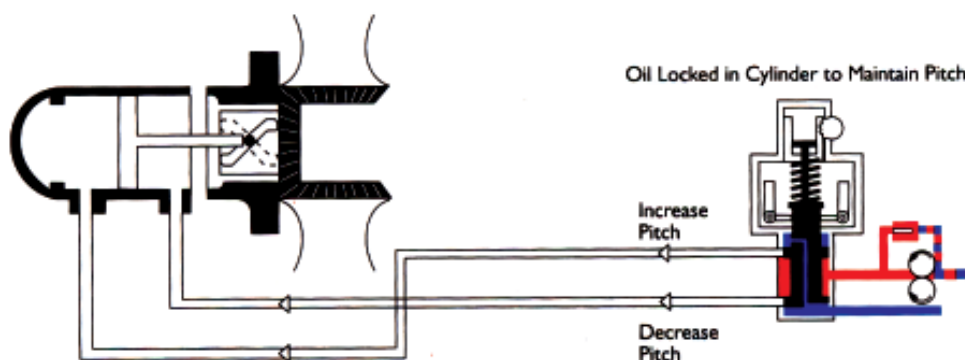
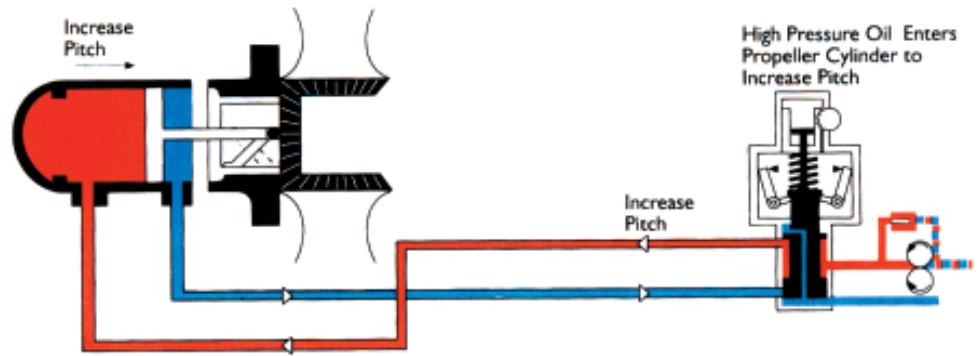

Fig 5-8c Engine Overspeed Correction



Variable Pitch Propeller Control

11. Variation of the blade pitch angle can be achieved automatically when varying the power of the engine, or selected manually. On small piston engine aircraft, the engine rpm and power are altered with different controls; engine rpm by direct control of the CSU, whilst engine power is adjusted using the throttle. Once the rpm is selected it is maintained by the CSU regardless of throttle movement.

12. Turboprop engines are generally controlled by a power lever and a condition lever:

Fig 5-9a Power Lever

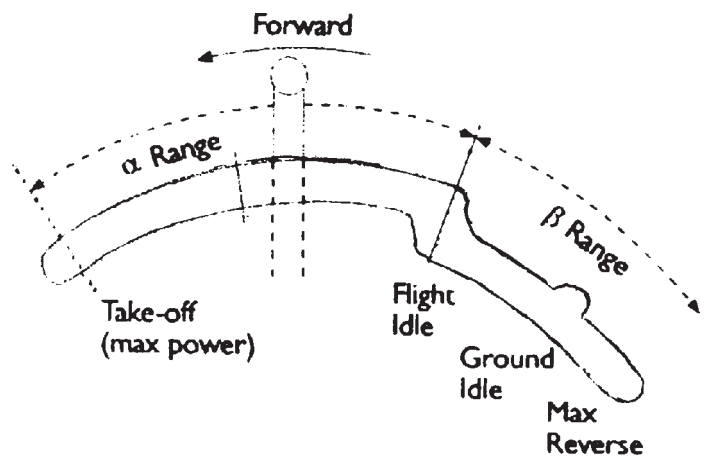

a. Power Lever. The power lever is used to control the power plant during all normal flight and ground operations (Fig 5-9a). The control works in 2 separate segments, the alpha (a) range and the beta (b) range. The alpha range controls the power plant during all normal flight conditions by adjusting the engine fuel flow, with the CSU adjusting propeller blade angle to maintain selected rpm (Fig 5-9b). In the beta range the pilot controls the propeller pitch overriding the CSU. A separate governor adjusts engine fuel flow to maintain engine rpm (Fig 5-9c).

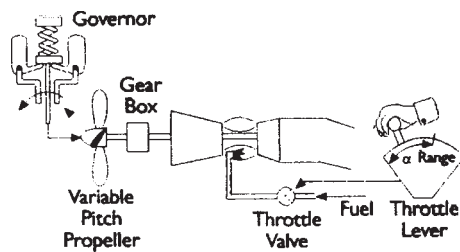

**Fig 5-9b** Alpha Control

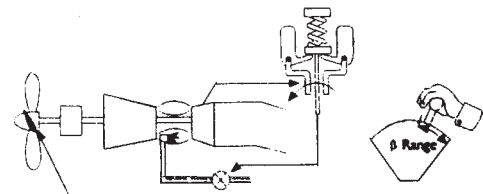
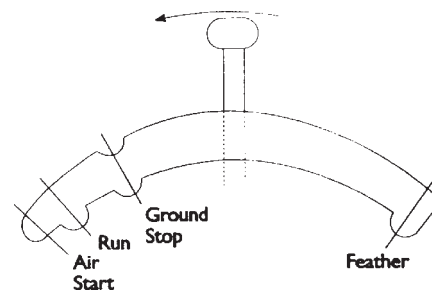

**Fig 5-9c** Beta Control

b. Condition Lever. The condition lever (Fig 5-10) is an override control and has the following discrete functions:

- (1) HP shut-off cock position.
- (2) Normal running position.
- (3) Air start position.
- (4) Propeller feathering position.

**Fig 5-10** Condition Lever



Propeller Safety Devices

13. Various safety systems are fitted to override the control system should a

malfunction occur. If control was lost the propeller would slam into fine pitch because of the centrifugal turning moment (CTM) of the blade. The effect of this would be dangerous in 2 respects:

- a. The torque required to turn the blades would be replaced by a windmilling torque which would assist the engine. Thus there would be a grave danger of engine and propeller overspeed.
- b. The propeller would cause a very high drag force to be applied to the aircraft. This would be particularly dangerous in multi-engined aircraft as it would give rise to a severe asymmetric condition.

14. The propeller control system has a number of safety devices to avoid overspeed and high drag caused by system failure (Fig 5-11). These are:

*Fig 5-11 Propeller Safety Devices*

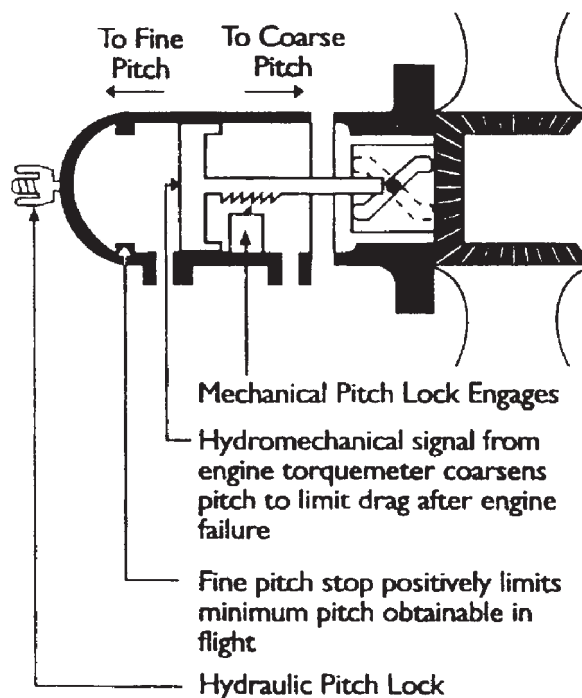

- a. Fine Pitch Stop. This is a mechanical stop which limits the degree of fine pitch that can be achieved in flight. For ground operations such as engine starting and the use of reverse pitch, the stop is disengaged, but it automatically re-engages after take-off.

b. Mechanical Pitch Lock. A mechanical pitch lock is incorporated in case of oil pressure loss or overspeed being sensed. The mechanical stop is a ratchet lock which prevents the propeller blades fining off, whilst still allowing them to move towards the coarse position if required.

c. Hydraulic Pitch Lock. This system operates a valve to trap the oil in the increase pitch side of the mechanism. It operates earlier than the mechanical pitch lock thus preventing impact when the ratchet is engaged. It acts when oil pressure loss is sensed.

d. Automatic Drag Link. A torque signal is fed to the controller, and if this falls below a certain value it indicates the propeller is at too fine a pitch for the flight mode. The blades are then moved into the fully coarse or feathered position. This situation could arise with either a CSU or engine failure.

15. As the oil pump for propeller operations is engine driven, a separate electrically driven pump is incorporated to complete the feathering operation whilst the engine is slowing down or stopped, and to enable the propeller to be unfeathered prior to engine restart.

### Propeller Operations

16. Feathering. Feathering of the propeller is normally carried out when the engine is shut down during flight. When feathered the propeller blade is presented with its leading edge facing into the direction of travel, thus reducing drag (see Fig 5-12).

**Fig 5-12** Range of Movement of a Typical Propeller

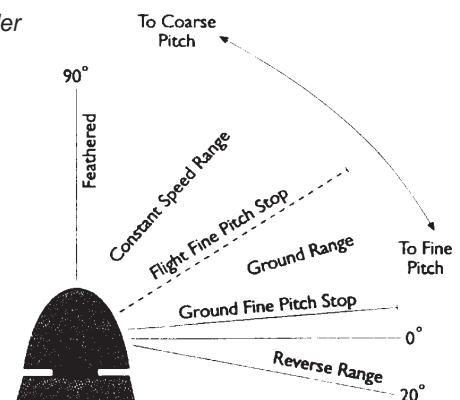

17. Reverse Pitch. Reverse pitch can be used both for braking on landing and

for ground manoeuvring. When selected, the fine stops are disengaged and the propeller blades are allowed to move past the flight fine position and into reverse pitch. This is a pilot selected manoeuvre with the engine speed being governed by its own fuel system governor.

18. Ground Fine. This blade angle is adopted during start up, to reduce the load on the engine.

### Self Assessment Questions

***Do not mark the paper in any way - write your answers on a separate piece of paper.***

1. Why is a propeller twisted?
2. What is the difference between fine and coarse pitch?
3. What is the function of a constant speed unit?
4. Why should propellers be capable of being feathered in flight?
5. How can a propeller operate as a brake on landing?



## CHAPTER 6

### THE JET ENGINE

#### Introduction

1. The principle of jet propulsion was demonstrated by Hero of Alexandria as long ago as the first century AD in the earliest 'steam engine' on record (Fig 6-1).

*Fig 6-1 Hero's "Steam Engine"*

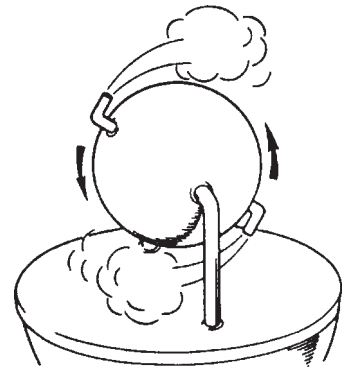

2. However, the jet engine, as we know it, did not become a practical possibility until 1930 when Sir Frank Whittle patented the design of his first reaction motor suitable for aircraft propulsion.
3. The early jet engines were rather crude by today's standards, but development was rapid and, though the gas turbine is traditionally associated with aircraft propulsion, it now has an ever-widening sphere of application, including ships, boats, trains, hovercraft, road vehicles, power stations and pumping equipment - all benefiting from the gas turbine's inherent qualities of high power, small size and low weight.

#### How does a Jet Engine Work?

4. The gas turbine engine, commonly referred to as the 'jet' engine, is an internal combustion engine which, like all such engines, produces power by the controlled burning of fuel.
5. In both the gas turbine and the motor car engine air is compressed, fuel is mixed with it and the mixture is burnt. The heat which results produces a rapid expansion of the gas and this is used to do work (Fig 6-2).

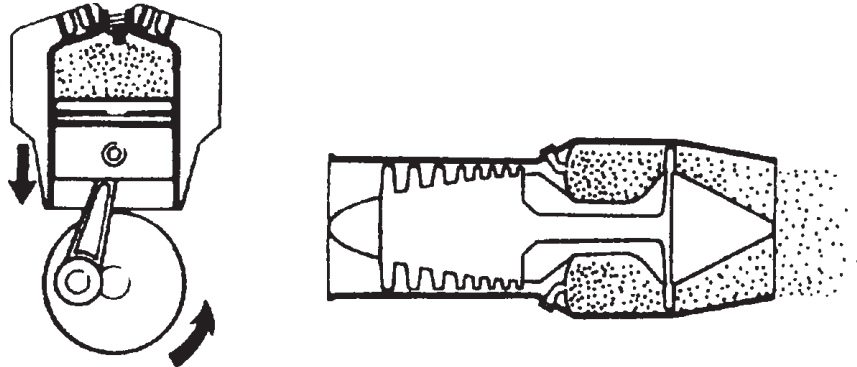
*Fig 6-2 Heated gas Expands*

6. In the car engine the burning is intermittent and the expanding gas moves a piston and crank to produce rotary or shaft power which drives the car wheels.

7. However, in the jet engine the burning is continuous and the expanding gas is simply forced out through a pipe or nozzle at the back of the engine - and confusion often arises, not so much regarding how the jet engine works but why it works. It is often thought that it works by 'pushing' the exhaust gas against the atmosphere - but in that case how would a rocket engine work in the vacuum of space?

8. The answer is that the jet engine, like the rocket, works by REACTION, on the principle expounded by the 17th century scientist Sir Isaac Newton - to every action there is an equal and opposite reaction.

9. Reaction can be demonstrated very simply by blowing up a child's balloon and releasing it. The 'power' which drives the balloon forward is the reaction to the compressed air being forced out of the neck of the balloon. When the balloon is inflated and the neck is closed, the balloon is in a state of equilibrium - the air inside is pressing equally all round the inside of the balloon. But when the neck is released, the air inside, under the pressure produced by the tension of the rubber envelope, is forced out. The air flowing through the neck of the balloon is now in action, producing a reaction equal to it, acting in the opposite direction. It is this reaction on the front inner surface of the balloon which drives it forward (Fig 6-3).

10. The 'hot end' of the jet engine can be regarded as the balloon. Gas is simply forced out through a pipe of the reaction to the expanded gas being forced out of the nozzle acts on those parts of the engine opposite the nozzle, mainly the 'nose' of the combustion chamber and on the tail cone. The reaction - the 'power' of the

engine - is transmitted from the engine casing to the airframe through the engine mountings, and is usually measured in pounds force (lbf), kilograms force (kgf) or the international unit, the newton (N).

**Fig 6-3** Action and Reaction

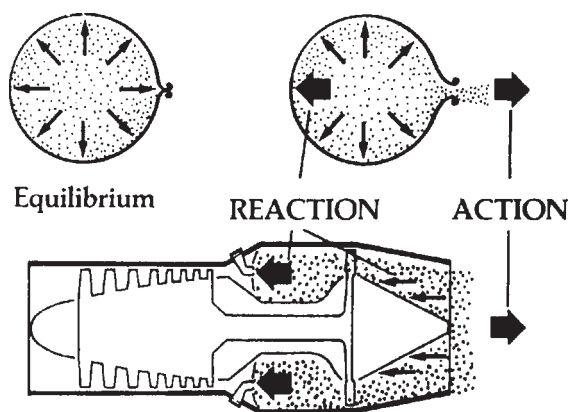

Layout of the Jet Engine

11. The jet engine is basically a gas generator - a machine for generating a large volume of gas which is forced out of the rear of the engine to produce a reaction in the form of forward thrust. The engine is therefore designed to collect a large volume of air, compress it, mix fuel with it and burn the mixture to produce the expansion which forces the gas out of the nozzle.

12. The engine has three main components - a compressor, a combustion chamber and a turbine.

**Fig 6-4** The Main Components of a Jet Engine

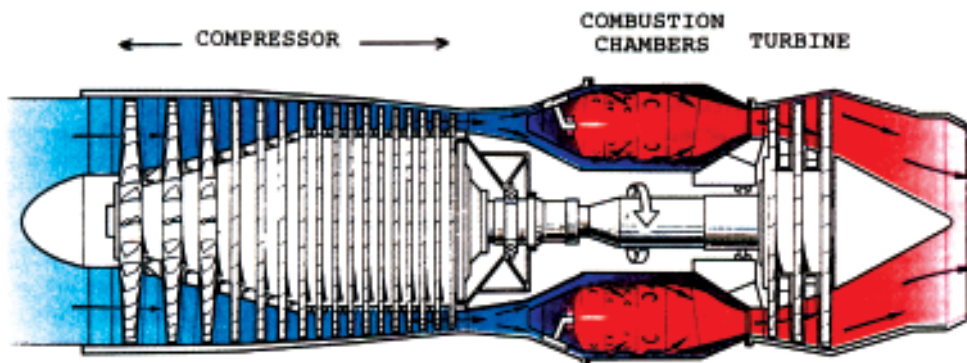

### The Compressor

13. The compressor, situated at the front of the engine, performs two functions - it draws air into the engine and it compresses it (in some engines by up to 30 atmospheres) before delivering it into the combustion chamber. Jet engine combustion will, in fact, work at atmospheric pressure, but efficiency and fuel consumption improve considerably when the pressure of the air is increased.

14. Compressors may be centrifugal or axial, the latter consisting of a number of stages of alternate rotating and stationary aerofoil-section blades which force the air through a convergent annular duct.

15. Many modern engines have more than one compressor because a high degree of compression requires a large number of compressor rows or 'stages'. Each stage has an optimum speed for best efficiency - the smaller the blades the higher the speed. If all the stages are on the same shaft, only a few of them will be operating at their optimum speed - the majority will be running either too fast or too slow. This problem is overcome by dividing the compressor into 2 or 3 parts, each driven by its own turbine and each rotating at its optimum speed. By this means, compression ratios up to 30:1 can be achieved, resulting in extremely high efficiency and very low specific fuel consumption.

### The Combustion Chamber

16. The air from the compression section, at anything up to 450 lb/sq in, passes into the combustion chamber. This is an annular steel 'flame tube' or ring of tubes designed to achieve the most efficient combustion of the fuel/air mixture so that the maximum possible heat energy is extracted from the fuel in order to give the greatest rise in temperature and hence expansion of gas.

17. The combustion chamber has a number of burners to vaporise the fuel before mixing it with the compressed air. Igniters are provided to initiate combustion. Unlike the piston engine, combustion is continuous.

### The Turbine

18. As a result of the burning of the air/fuel mixture, gas velocity and temperature in the combustion chamber increase rapidly and the gas is forced out of the rear

of the engine, through the turbine. The turbine consists of one or more stages of alternate rotating and stationary aerofoil-section blades. It is attached by a shaft to the compressor, and in the simplest form of jet engine, the turbojet, its function is to absorb just enough energy from the gas stream to keep the compressor rotating at its optimum speed - the remaining energy provides the thrust.

19. The complete rotating assembly - compressor, shaft and turbine - is carried on bearings and is known as a 'spool'. In a multi-spool engine, each compressor is driven by one or more turbine stages.

20. In the turbojet and in another turbine derivative, the turbofan, the turbine is designed to absorb just sufficient energy from the gas stream to drive the compressors, leaving the remainder to provide the thrust. In other derivatives, the turboprop and turboshaft, there is an additional turbine which is designed to absorb as much energy as possible from the gas stream in order to drive the propeller or power output shaft respectively.

#### **Types of gas turbine engines**

#### Main Types of Gas Turbines

21. There are 4 main types of gas turbine engines - the first 2, turbojet and turbofan, are 'reaction' engines, deriving their power from the reaction to the jet. As indicated above, the second two, the turboprop and turboshaft, operate on a different principle, where the energy in the gas is used to drive a separate turbine which is connected to a propeller or power output shaft.

**Fig 6-5** The Turbojet (Olympus 593)

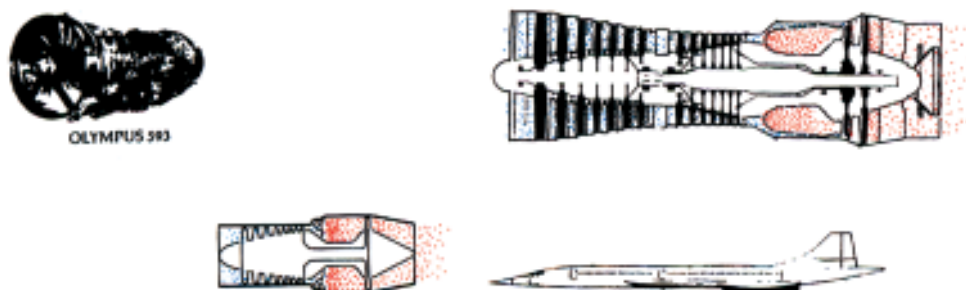

### Turbojet

22. The turbojet, the simplest and earliest form of gas turbine, is used principally in high speed aircraft where its relatively low frontal area and high jet velocity are advantages. Examples are the OLYMPUS 593 in the Concorde supersonic transport and the VIPER in a variety of military aircraft (Fig 6-5) including the Dominie/HS125.

### Turbofan

23. The turbofan is probably the most common derivative of the gas turbine for aircraft propulsion. It is a 'bypass' engine, where part of the air is compressed fully and passes into the combustion chamber, while the remainder is compressed to a lesser extent and ducted around the hot section. This bypass flow either rejoins the hot flow downstream of the turbine, as in the SPEY, or is exhausted to atmosphere through an annulus surrounding the hot exhaust, as in some versions of the RB 211. In both cases the result is reduced overall jet velocity, giving better propulsive efficiency at lower aircraft speeds, lower noise levels and improved specific fuel consumption, features which make the turbofan ideal for both civil and military aircraft.

**Fig 6-6** *The Turbofan (RB 211)*



24. Examples are the RB 211 in the Boeing 747 and 757, the SPEY in the 1-11 and F28, the ADOUR in the Jaguar and Hawk, and the RB 199 in the Tornado. The PEGASUS in the Harrier is a variation of the turbofan (Fig 6-6).

### Turboprop

25. The turboprop is a turbojet with an extra turbine which is designed to absorb all the energy remaining in the gas stream after sufficient has been removed to drive the compressor; in practice there is always a small amount of 'residual' thrust in the exhaust gases. The 'power' turbine drives the propeller through a reduction gear, usually at the front of the engine.

26. The turboprop is a very efficient power unit for relative low speed, low altitude

aircraft (eg 400 knots/30,000 ft) though recent strides in propeller technology, in the pursuit of quietness and economy, have demonstrated the feasibility of a new generation of high speed propeller driven aircraft. The power of this type of engine is measured in total equivalent horsepower (tehp) or kilowatts (kW) - the shaft horsepower (shp) plus the residual thrust.

27. Examples of the turboprop are the DART in the 748 and F27 and the TYNE in the Transall C-160 and Atlantic (Fig 6-7).

**Fig 6-7** The Turboprop (Tyne)

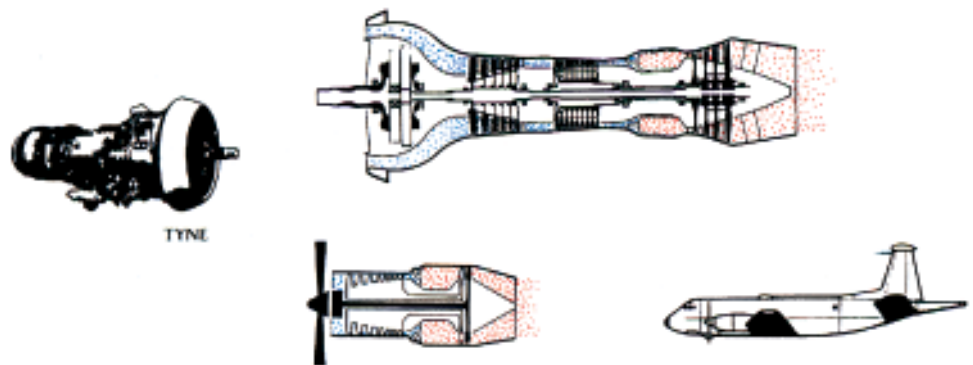

### Turboshaft

28. The turboshaft is virtually a turboprop without a propeller, the power turbine being coupled to a reduction gearbox or directly to an output shaft. As with the turboprop, the power turbine absorbs as much of the remaining gas energy as possible and the residual thrust is very low. The power of this type of engine is normally measured in shaft horsepower (shp) or kilowatts (kW). The most obvious application of the turboshaft is the helicopter, where the engine drives both the main and tail rotor, though turboshafts are widely used in industrial and marine application, including power and pumping stations, hovercraft and ships.

29. Examples of the turboshaft are the GEM in the Lynx and the GNOME in the Sea King helicopters, and industrial and marine versions of the RB 211 and OLYMPUS (Fig 6-8).

**Fig 6-8** The Turboshaft (Gem)

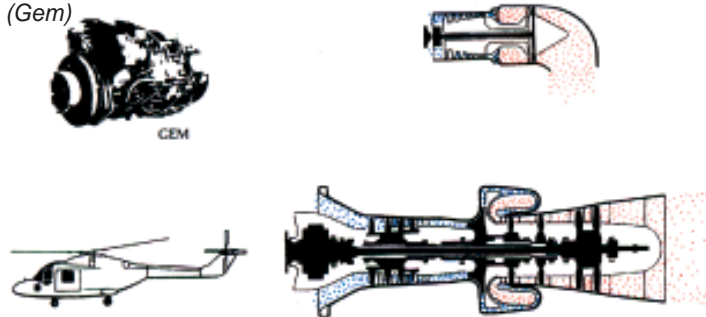

### Variations

30. Developments which add to the applications of the jet engine include:
- a. Vectored Thrust. Thrust-vectoring is a means of changing the direction of the jet and hence the reaction or thrust in order to meet the requirements of V/STOL (vertical or short take-off and landing) aircraft. An example is the PEGASUS turbofan, which powers the Harrier, where the engine has 4 linked swivelling nozzles which direct the jet downward for VTOL, through an arc to rearward for forward flight. In the Pegasus the fan or bypass air is discharged through the front 2 nozzles and the hot exhaust gas through the rear 2 (Fig 6- 9).

**Fig 6-9** Vectored Thrust

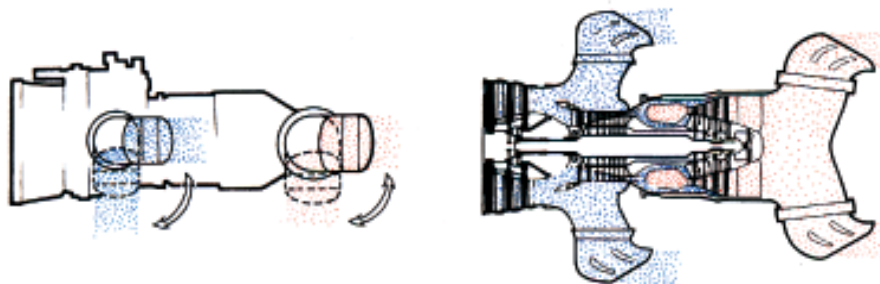

- b. Geared and Variable-Pitch Fans. The geared fan is a development of the turbofan aimed principally at reducing fan noise by reducing its speed via a reduction gearbox while maintaining a high engine speed for maximum



efficiency. Geared fans with variable pitch blades allow even greater ease of engine control and flexibility of aircraft operation (Fig 6-10)

**Fig 6-10** Geared fans

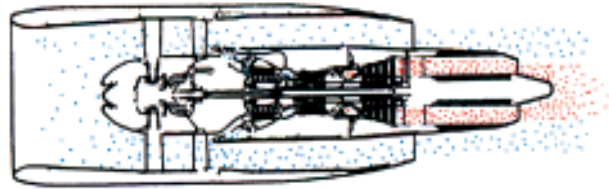

c. Liftjets. Liftjets are very compact turbojets which are installed vertically in an aircraft to provide purely vertical thrust for take-off, hovering and landing. Liftjets are shut down during forward flight (Fig 6-11).

**Fig 6-11** Liftjets

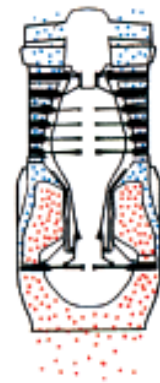

d. Ramjets. A ramjet is virtually a turbojet from which the compressor and turbine have been removed. Compression is achieved by the 'ram' pressure in the intake and for this reason the engine can operate efficiently only above about Mach 1 - the speed of sound. The ramjet has no moving parts and is the simplest of all air-breathing engines (Fig 6-12).

**Fig 6-12** Ramjets

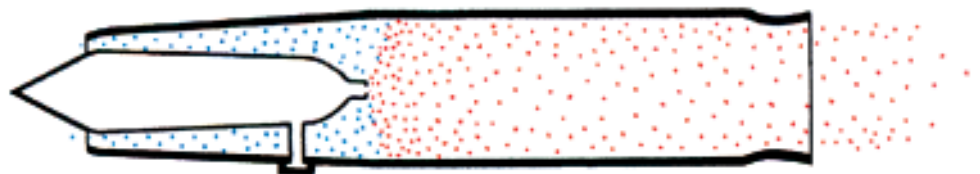

e. Afterburning. Afterburning or reheat provides a means of increasing thrust without increasing the engine's frontal area. Unlike a piston engine, the fuel in a jet engine is burned in an excess of air, so there is still a certain amount of oxygen present in the exhaust. These gases will therefore support combustion and it is possible to burn additional fuel in the jet pipe to increase the exhaust velocity and consequently increase the thrust of the engine. In a turbofan, where the bypass air provides even more oxygen, thrust increases up to 100% are possible by this method; it is normally applied to military engines for short-duration boost, eg for take-off or combat (Fig 6-13).

**Fig 6-13** Afterburning

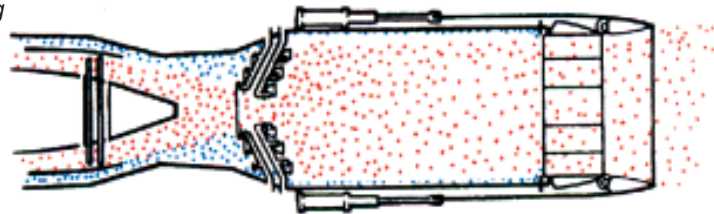

f. Reverse Thrust. Thrust reversal is simply a method of altering the direction of the jet reaction, like thrust vectoring, to meet an aircraft's operational requirement, in this case slowing the aircraft after landing. The jet deflection is achieved by 3 main methods; one uses clamshell-type deflector doors to reverse the exhaust gas stream; the second uses a retractable ejector to do the same thing; the third, used on high bypass ratio turbofans, uses blocker doors to reverse the cold stream airflow, which provides the majority of the thrust (Fig 6-14).

**Fig 6-14** Reverse Thrust

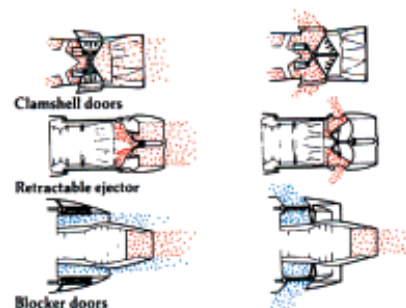

### Pressures, Temperatures and Velocities

32. Fig 6-15 indicates the pressures, temperatures and velocities which occur

in a Rolls-Royce Spey engine, the arrows above the table indicating the part (stage) of the engine where they apply.

**Fig 6-15** Pressures, Temperatures and Velocities

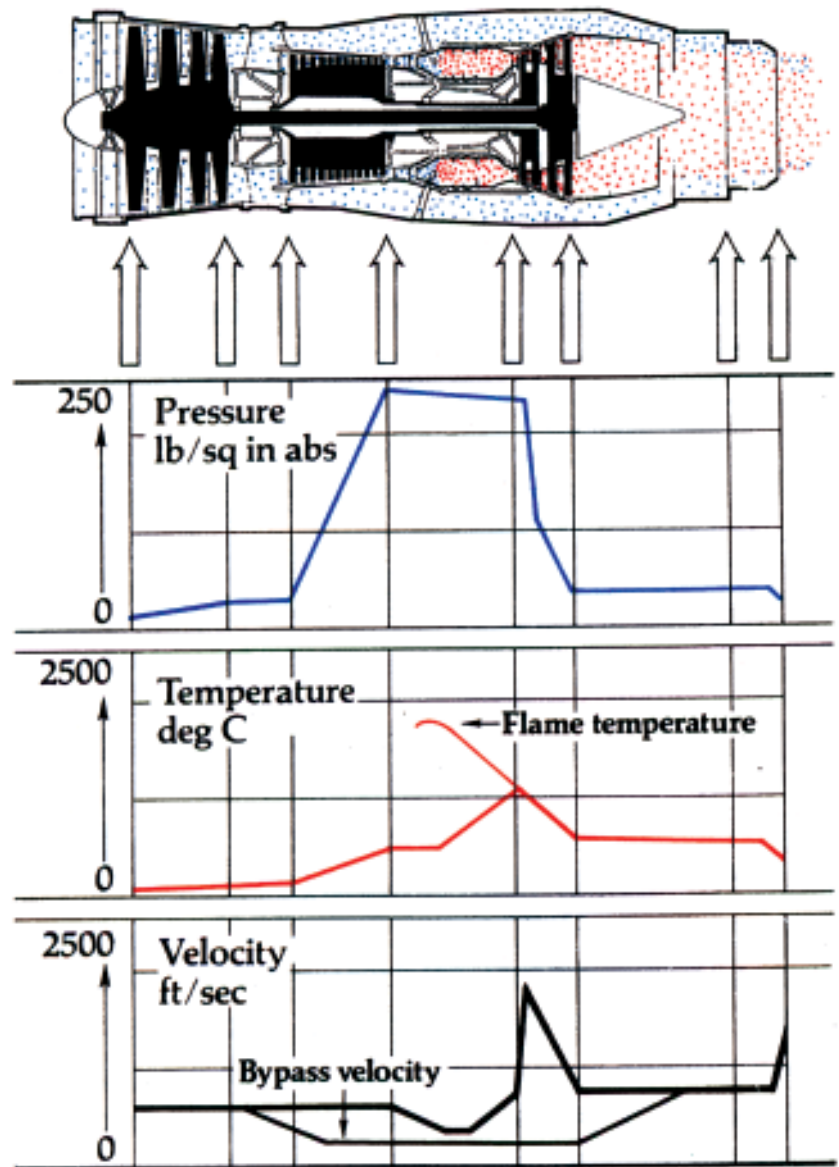

## Self Assessment Questions

***Do not mark the paper in any way - write your answers on a separate piece of paper.***

1. When was the first practical reaction motor designed - and by whom?
2. What is the fundamental principle on which all heat engines work?
3. Why does a jet engine work?
4. What units are normally used to express the power output of a pure jet engine?
5. Why do modern jet engines have more than one compressor?
6. What is the fundamental difference between the combustion process of the internal (piston) combustion engine and the jet engine?
7. What drives the compressor?
8. Where would you expect to find a turboshaft engine?
9. What is the purpose of geared and variable pitch fans?

## CHAPTER 7

### ROCKETS

#### Rocket Propulsion

1. Jet engines will not work in space; they need the Earth's atmosphere, because they draw in air and use the oxygen in it to burn fuel to operate the engine. The engine then throws gases backwards, so as to propel the aircraft forward. Rockets are much simpler and they carry fuel (or "propellants") that do not need atmospheric oxygen. A rocket is basically a tube, closed at one end, containing a propellant. The propellant burns very quickly, producing a fast-moving exhaust flow. The propellant might be a liquid chemical fuel (eg kerosene/paraffin) with an oxidizing agent (liquid oxygen), or it might be a solid chemical.

#### Rocket Theory

2. Rocket propellants burn quickly or react together violently to produce a fast exhaust flow. Such a flow of gas constitutes an 'action'; and Newton's third law states that every action must have an equal and opposite reaction. The reaction to this rearward gas flow is a forward thrust on the rocket itself. The magnitude of the force is given by Newton's second law, which states that force is proportional to the rate of change of momentum (mass times velocity). In simple terms, this means that the larger the force produced by the burning fuel, then the faster the rocket will move! Note that all this is independent of the medium (eg air) that the rocket may be in. Thrust is derived from the reaction to the gas momentum. **NOT BY PUSHING ON THE MEDIUM**. A rocket works perfectly well in the vacuum of space – and in fact benefits from the absence of air resistance.

#### The Rocket Motor

3. The heart of a rocket motor is the combustion chamber and exhaust nozzle. At every instant, the momentum of exhaust products is producing a forward thrust which is transmitted to the forward walls of the combustion chamber and on to the rocket. If the burning is even, the thrust will be constant with time. If we ignore all other forces, the rocket will accelerate forwards in accordance with Newton's second law, Force = Mass x acceleration or  $F \div M = a$ . For example a 5000 kg thrust

engine in a 5000 kg rocket will give an acceleration equal to the force of gravity (1g). However, as fuel is used, weight falls and the same 5000 kg thrust on the rocket, now reduced in weight to, say, 2500 kg will give an acceleration of 2g.

4. Apart from combustion to produce thrust, liquid propellants are put to other uses, particularly in a large rocket motor. As an example we can look at a rocket which uses liquid oxygen (the oxidant) and kerosene (the fuel). Liquid oxygen is pumped directly to the combustion chamber, but some is also used to drive a pump turbine. Pumping is needed because of the enormous fuel consumption of large rocket engines – the 5 engines of the Saturn V (which took the manned craft Apollo 11 to the moon) used 12 tonnes of fuel per second! Gaseous oxygen from the gas generator can also be used as a power source for ancillary equipment.

5. The kerosene fuel is pumped along a very long tortuous path around the rocket nozzle, before entering the combustion chamber. There are 2 reasons for this arrangement:

a. The exhaust gases flow through the nozzle at very high temperatures (typically  $3,000^{\circ}\text{C}$ ) which could destroy the material of the nozzle very quickly, unless some form of cooling were employed. The kerosene flowing through the tubes round the nozzle cools the metal – this function is called regenerative cooling.

b. As the kerosene cools the nozzle gets hot and it is next fed to the combustion chamber. There, because it has been pre-heated, it vaporizes more speedily. This improves the combustion process.

**Fig 7-1** The Components of a Liquid Propellant Rocket Motor

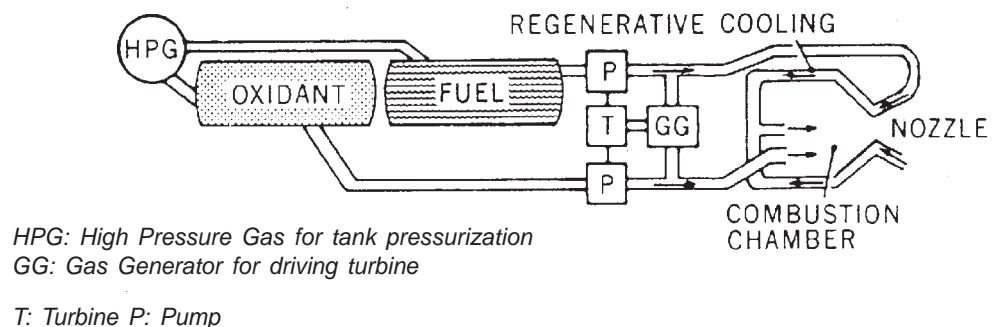

### Solid Propellant Rocket

6. The essentials of a solid propellant rocket are shown in Fig 7-2.

7. This form of rocket has no moving parts and is by far the simplest in construction; it is reliable, and solid propellants are comparatively safe and easy to handle. However, it is difficult to control the exact thrust output of a solid propellant and the performance of solid fuels is generally not as high as that of liquids.

**Fig 7-2** A Solid Propellant Rocket

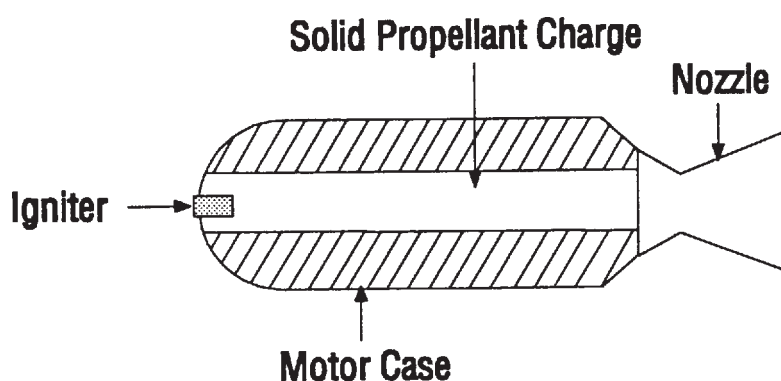

### Efficiency and Specific Impulse

8. For conventional air-breathing engines the fuel consumption gives a good indication of the efficiency of the motor. Rocket engineers rarely mention fuel consumption as it would be embarrassingly high by comparison with other large engines. They use another term to quantify the rocket engine efficiency, called Specific Impulse (SI). Here "impulse" means the force applied (ie the thrust) multiplied by the duration of its application – a measure of the momentum change achieved. "Specific" Impulse is this figure, divided by the mass of the propellants used. Thus, SI indicates the effectiveness of the propellant in producing a change in velocity of the vehicle it is propelling. For example, if propellant A can produce the same thrust for the same time as propellant B, but uses less mass than B in doing so, then A has a higher SI than B – ie it is more efficient than B.

9.  $SI = \text{thrust (in kg)} \times \text{time (in seconds)} \div \text{mass of fuel used (in kg)}$ . The thrust kg mathematically cancels out the mass kg leaving secs. In other words, the unit

for SI is seconds. An SI of 250 seconds, a typical value, would mean that 1 kg of propellant would give 250 kg of thrust for one second, or 25 kg of thrust for 10 seconds, or 2.5 kg of thrust for 100 seconds, and so on; thrust and time are interchangeable in the equation. The actual burning time would depend on the nature of the fuel and the combustion conditions.

### Typical Fuels

10. Four typical liquid propellants and one solid propellant are described below:

11. Liquid Hydrogen and Liquid Fluorine. Liquid hydrogen and liquid fluorine offer one of the highest SIs for the bi-propellant, 390 seconds at sea level (480 in space). However, there are disadvantages:

- a. Liquid hydrogen boils at  $-253^{\circ}\text{C}$ , so special storage and fuel tanks are needed to stop it evaporating rapidly.
- b. Liquid hydrogen has a very low density – one fourteenth of that of water – so huge fuel tanks are needed for quite a small mass of liquid hydrogen.
- c. Fluorine is highly toxic, it boils at  $-188^{\circ}\text{C}$ , and it is one of the most chemically active elements known, combining with every gas except nitrogen, chlorine and inert gases. You can imagine the storage problems!
- d. Finally, when the 2 liquids combine and combust they produce hydrofluoric acid, a very corrosive substance which is used for etching glass!

12. Liquid Hydrogen and Liquid Oxygen. The SI of liquid hydrogen and liquid oxygen nearly matches that of hydrogen and fluorine, and the product of combustion – ie steam, is harmless. The low density and temperature of liquid hydrogen remain a problem, but liquid oxygen is less demanding on storage as it is relatively dense (1.14 times that of water). The liquid hydrogen/ oxygen combination has much to offer – in fact it is used for the main engines of the Space Shuttle.

13. Liquid Oxygen and Kerosene. Kerosene is cheap, plentiful and safe to handle. More importantly, its relative density of 0.8 (ie 80% of that of water) requires smaller tanks than liquid hydrogen; and it can be stored at normal temperatures.



Despite having a lower SI than liquid hydrogen/oxygen, it has been a most useful propellant for the United States programme in the past and is still used for the Soviet Vostock craft.

14. Unsymmetrical Dimethyl Hydrazine and Red Fuming Nitric Acid (UDMH and RFNA). UDMH with RFNA is an effective but unusual fuel combination. A small amount of fluorine is normally added to prevent the nitric acid from eating away the steel fuel tanks. The 2 liquids do not boil off. The combination also has the advantage of being self igniting – the propellants ignite on contact and so no ignition system is required. There are however, obvious dangers in handling these chemicals.

#### Multi-Stage Rockets

15. At launch, a rocket has to lift its payload, plus its own weight and that of all its fuel. Typically, a single rocket might burn for 3 minutes and reached a height of 60 km, which is not high enough for any viable orbit. One solution would be to have a lot more fuel available at launch – but this would mean much more weight at launch (extra fuel plus extra tanks).

**Fig 7-3** Multi Stage Rocket

- A - First Stage
- B - Second Stage
- C - Third Stage
- D - Payload
- E - Booster Rocket
- F - Booster Rocket
- G - Protective Skirt
- H - Protective Skirt

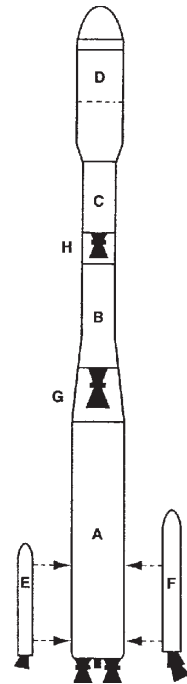

So, although the rocket might now reach 60 km with some fuel left, much of that fuel would next be used in boosting the extra tanks – now empty – to a slightly higher altitude along with the payload. A much more efficient technique is to use multi-stage rockets. In the diagram, the huge first stage (A) does the giant's share of the job – lifting itself and the rest of the assembly off the ground and accelerating it to, say, 3 km/sec and a height of 80 km. Stage A is now dead weight, so explosive bolts release it and it falls to Earth, breaking up and burning as it does so. Meanwhile, the second stage rocket (B) ignites and continues to accelerate the assembly to, say 6 km/sec and 150 km. Stage B has a much easier job than stage A, as it has a much smaller mass to propel, and the atmospheric drag is a tiny fraction of what it was earlier in the flight. In our example, stage B is in due course discarded as was stage A, and the third stage (C) ignites to take the payload up to orbit height and speed.

16. Depending upon the mass of the payload, some assemblies might have only 2 stages, whilst others might have 3 stages plus booster rockets (e and F), of various types and capability, clamped to the outside of stage A for launch. This gives extra flexibility in the size of payload to be carried. The booster rockets can be the liquid-fuelled or the solid-fuelled type. They are normally used in pairs, with either 2 or 4 on one vehicle. They can be mixed (liquid and solid fuel) when 4 are used, but not for 2 or 3, as their differing power and burning times would cause asymmetric thrust which could throw the vehicle off course, and could even make it crash. Typical burning times for booster rockets are around 45 seconds (solid fuel) and 2\_ minutes (liquid), which is the crucial early stage of launch when the vehicles mass is vast and air resistance is high. Boosters are jettisoned as soon as they have used up their fuel.

17. There might also be more than one satellite in the payload (S). In this case the third stage motor would switch off at the desired orbit height and speed, and the satellite in the nose-cone would separate. The aerodynamic cone itself, which merely protects the satellite from air pressure and friction in the lower atmosphere – would probably have been discarded earlier. This satellite would almost certainly have its own rocket for adjusting, or even changing, its orbit. This on-board rocket would have small thruster nozzles on all sides for changing the satellite's attitude (for example, to point its aerals in a specific direction), plus a main nozzle at the

back for propulsion purposes (eg to adjust orbit speed, or to change orbit). The second satellite would be taken by the third stage rocket to another orbit height, or to another part of the sky at the same orbit height as the first, according to the jobs the satellites will have to do.

### Re-Usable Vehicles

18. From the earliest days the cost of launching hardware into space was huge. Most launch rockets can be used only once. Having placed their payload into Earth orbit, they either remain in orbit as space debris, or re-enter the atmosphere and burn up. To reduce costs, the Americans and the Russians both developed re-useable launch vehicles. The American version is called the Space Shuttle and the Russian version is called Soviet Shuttle Buran. The American space agency NASA designed the Space Shuttle, to carry satellites in its cargo bay and launch them into orbit. It can simply place them into its own standard orbit at about 300 km above the ground, but if a higher orbit is needed, the satellite will have a built-in rocket. Such a rocket would, of course, be much smaller and cheaper than one which would be needed to lift the satellite all the way from the ground. The Space Shuttle can also be used to retrieve satellites from their orbits and repair them for re-release or bring them back to Earth for further work – a capability first proved during the Shuttle missions in 1984. The Hubble Space Telescope was a highly publicized repair operation in space, successfully carried out during a Shuttle mission.

### The Space Shuttle

19. At launch, the American Space Shuttle has 4 main parts:

Two solid-fuel rocket boosters (SRBs)

One external tank (ET)

One orbiter

**Fig 7-4** The American Space Shuttle

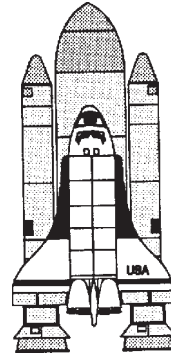

---

20. During take-off the Shuttle is propelled by its own rocket engine fuelled from the ET together with the 2 x SRBs. The SRBs separate at a height of 45 km, some 2 minutes into the flight. The booster rockets are parachuted to earth and are retrieved for future use. The next stage to depart is the ET. This falls away at a height of 120 km, nearly 9 minutes into the flight. The ET burns up when re-entering the Earth's atmosphere and is only part of the vehicle that is not re-useable. The Shuttle has 2 on-board engines called orbital manoeuvring system (OMS) which are used to position the vehicle in the required orbit before commencing the mission. For the return to Earth the OMS is used to correctly position the Shuttle into the descent attitude and trajectory for re-entry. Once it enters the atmosphere, the Shuttle can also use aerodynamic controls, and in due course, it lands like a glider – but on a very long runway!

The Soviet Shuttle.

21. Shuttle Buran has no engines of its own and for launching it relies solely upon the booster rockets it piggybacks

---

**Fig 7-5** The Soviet Shuttle Buran

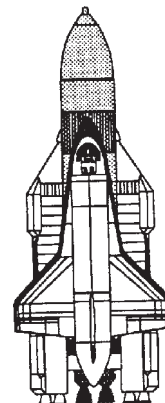

***Do not mark the paper  
in any way - write your  
answers on a separate  
piece of paper.***

### Self Assessment Questions

1. What is Newton's third law?
2. How is thrust obtained in a rocket?
3. Give 3 examples of typical fuels used in rockets
4. What are the 3 main parts of the American Space Shuttle?
5. Which part of the Shuttle is not retrieved for further use?



## INSTRUCTORS GUIDE

### THE PISTON ENGINE

**Page 33.3.1-1 Para 2**

Piston Engine

1. When a person stands close to a motor cycle or a car with the engine running it is possible to feel the heat given off by the engine. This is to be expected as these engines are heat engines - which means that they derive their power from the energy obtained when fuel is burnt.
2. Everyone knows that when a gas is heated it expands. Thus, balloons sometimes burst in a warm room; dents in a ping pong ball can be removed by holding the ball in hot water. Imagine a sealed cardboard box filled with household gas from the gas stove. If a lighted match were put in the box, what would happen? Undoubtedly, there would be a loud explosion, a flash, and the box would split from end to end. The sequence of events, if this could be seen in slow motion, would be the flames heating the gas, causing it to expand and increase its pressure until the box could no longer hold against it and burst.
3. A car or motor cycle engine burns gas in a combustion chamber in the engine and uses the force of the expanding gas to push a piston down a cylinder. this straight down force is then changed into a rotary movement that turns the wheels.
4. The fuel in common use is petrol, known in the Service as gasoline. The liquid gasoline is first turned into a gas and mixed with air. The mixture is ignited by an electrical spark.

**Page 33.3.1-7 Para 14b**

Ignition

1. It has been stated that the gas within the combustion chamber is burnt. All burning takes time, perhaps only a fraction of a second, but still a period of time. It follows that if a charge is ignited at the top of the power stroke when the piston is at the start of its downward travel, the piston will have moved part of the way down before all of the gas has been completely burnt. As a result, part of the effectiveness of the expanding gas will have been lost. To prevent this loss of energy, it is usual to ignite the charge slightly before the piston reaches the top of the compression stroke. In this way the gas is completely burnt and the full force applied to the piston just after it begins its downward movement.
-

## CHAPTER 2

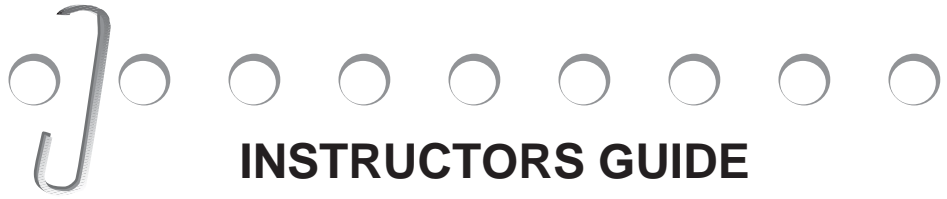
CARBURATIONCarburation**Page 33.3.2-1 Para 2**

1. During the induction stroke of the four stroke cycle, a charge of combustible gas is drawn into the engine. This gas is a mixture of gasoline and air necessary for combustion. The necessary oxygen is readily obtained from the air of the surrounding atmosphere, but the gasoline must be metered to the engine to maintain the right proportion of gasoline to air. (About 15 parts of air to 1 of gasoline). The supply of this mixture to the engine must also be metered to control the power output. This is done by the carburettor. It mixes the gasoline with the air and delivers the mixture to the engine.
-

CHAPTER 3



**INSTRUCTORS GUIDE**

IGNITION

Spark Plugs

**Page 33.3.3-4 Para 9**

1. A spark plug is designed for use in a particular type of engine and it is important that only the approved type is fitted. Periodically, the plugs are removed from the engine, cleaned, the gaps re-adjusted to the correct size, and the insulation properties checked.
-

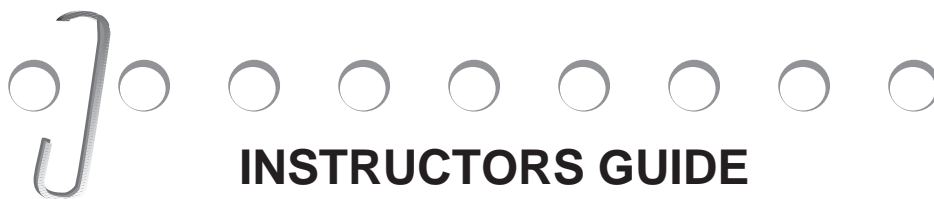

## CHAPTER 6

**INSTRUCTORS GUIDE**THE JET ENGINEJet Engines**Page 33.3.6-1 Para 3**

1. There were numerous developments in aero-engines during the Second World War, but the most important one, the jet engine, came too late to make much difference to the fighting. Much pioneer work was done by Sir Frank Whittle, who joined the Royal Air Force as an aircraft apprentice in 1923 and made his first successful jet engine in 1937; but it was the Germans who made the first successful jet aircraft in history - the Heinkel 178, which flew in August 1939.
2. The first British jet aircraft, the Gloster E28/39, flew in May 1941, powered by an engine of Whittle's design. The second aircraft powered by his engine was the Gloster Meteor which became the only allied jet aircraft to see operational service during the war.
3. In the later stages of the war, the Germans were desperately trying to stop our bomber formations from attacking their cities and one of the weapons they used was the jet fighter. Several types were flown, the most successful being the Me262 that saw operational service in 1944 and had a top speed of 525 mph. (The top speed of the Meteor was 480 mph).

Principles of a Jet Engine**Page 33.3.6-1 Para 4**

1. When a rifle is fired, the bullet is forced out of the barrel and the rifle is jerked backwards into the shoulder. If the rifleman does not hold the rifle tightly, he may even get a bad bruise on his shoulder. If a machine-guns instead of a rifle is fired, it gives a rapid series of backward movements or recoils. What will happen if the machine-gun is fixed to a boat instead of being held by a gunner, and what will happen if the gun is mounted pointing over the stern? Each shot will result in a pressure on the stern of the boat, and after a few rounds the boat will start to move forward.
  2. The important point to remember is that the bullets from the gun do not have to hit anything, nor does the gunner reach out and push the boat in any way. The movement of the bullet in one direction reacts on the gun and pushes it in the other.
  3. The jet engine works in exactly the same way, but instead of bullets coming out of the back, very hot gases are ejected in a steady flow, giving one long recoil. The gases do not push against the air behind the engine, they merely cause a reaction, or thrust, forward.
-

## Self Assessment Questions - Answer Sheet

### Chapter 1 - The Piston Engine

1. By burning liquid fuel inside the engine, where the pistons are located.
2. The temperature rises.
3. An electric spark.
4. Top Dead Centre. It occurs when the piston reaches the highest point of its travel.
5. "Valve Lag" means that the inlet valve closes after the piston has passed BDC and that the exhaust valve closes after the piston has passed TDC.
6. "Ineffective crank angle" means that near TDC and BDC a fairly large rotation of the crankshaft causes only a small linear movement of the piston.
7. The crankshaft operates once for each two revolutions of the crankshaft.

### Chapter 2 - Carburation

1. The correct fuel to air ratio is assured by fitting a suitable sized jet.
2. The object of carburation is to provide the engine with a combustible mixture of air and fuel in the right quantities.
3. The Air Intake, the Main Jet and the Float Chamber.
4. When the fuel level in the chamber falls because of the fuel flow to the engine, the float also falls and allows more fuel to enter the chamber.
5. The Float Chamber.
6. More fuel flows through the jet to mix with the increased flow of air.
7. Use a finely-tempered needle and using 2 or more main jets in the carburettor.
8. The supercharger is a centrifugal pump, driven from the crankshaft - between the throttle valve and the engine cylinders.
9. A boost control measures manifold pressure and controls throttle valve movement to give the amount of boost thrust the pilot has set with his throttle lever.
10. A turbo-charger operates in much the same way as a supercharger, however it is driven by exhaust gases and not directly driven by the engine.

## Self Assessment Questions - Answer Sheet cont...

### Chapter 3 - Ignition - Piston Engine

1. A dual ignition system provides safety (the engine will still work if one system fails) and it improves engine power.
2. The incorrect setting produces a weak spark at the wrong time and adversely affects engine performance.
3. The capacitor (condensor) reduces burning or pitting of the contact breaker points during the "make and break" action. It also causes the primary current to fall to zero more quickly and thus ensures a faster collapse of the magnetic field.
4. The strength of the electromotive force depends on the speed of rotation and the strength of the magnet.
5. By opening the contact breaker points.
6. The firing order of the cylinders is arranged to even the load along the crankshaft. For instance on a 4 cylinder engine, the firing order is usually starting from the front cylinder 1, 3, 4, 2.

### Chapter 4 - Lubrication and Cooling - Piston Engines

1. Friction is the resistance that has to be overcome to allow movement between sliding surfaces.
2. No. Some are thinner or thicker.
3. Lubricating oil for an aero engine should be of a suitable viscosity for maximum loads and also retain this viscosity over the full range of engine temperature.
4. "Splash Oil" lubricates the ball and roller bearings, gear teeth, piston rings, cylinder walls and other moving parts, and then drains to the sump or well at the bottom of the crankcase.
5. It stops excessive high oil pressures.
6. The engine components tend to have a shorter life than those of a liquid-cooled motor.
7. To ensure the coolant is not exposed to atmospheric pressure, it raises the boiling point of the coolant, which enables the engine to operate at a higher temperature, and hence more efficiently.

## Self Assessment Questions - Answer Sheet cont...

### Chapter 5 - Propellers

1. The “bladetwist” allows the blade to maintain an efficient angle of attack along the full length of the propeller blade.
2. “Course pitch” is when the blade pitch angle is at the highest angle in its designed range, and “fine pitch” is when the angle is at its smallest.
3. The engine/propeller speed is kept at its pre-selected value by the Constant Speed Unit.
4. Feathering of the propeller is normally carried out when the engine is shut down during flight. When feathered, it reduces drag.
5. By using Reverse pitch.

### Chapter 6 - The Jet Engine

1. In 1930 by Sir Frank Whittle.
2. In both the gas turbine and the motor car engine air is compressed, fuel is mixed with it and the mixture is burnt.
3. A jet engine works by reaction.
4. Pounds force (lbs), Kilograms force (kgf) or the international unit, the Newton (n).
5. Many modern engines have more than one compressor because a high degree of compression requires a large number of compressor or “stages”.
6. Combustion is continuous.
7. The turbine.
8. In the Lynx and Sea King helicopters.
9. Changing the direction of the jet used in V/Stol aircraft.
10. Geared fans with variable pitch blades allow even greater ease of engine control and flexibility of aircraft operation.

## Self Assessment Questions - Answer Sheet cont...

### Chapter 7 - Rockets

1. Newton's third law states that every action must have an equal and opposite reaction.
2. Thrust is obtained from the reaction to the gas momentum, not by PUSHING ON THE MEDIUM.
3. Typical fuels are Liquid Hydrogen and Liquid Fluorine, Liquid Hydrogen and Liquid Oxygen and Liquid Oxygen and Kerosene.
4. The 3 main parts of an American space shuttle are:  
Two solid-fuel rocket boosters (SRBs)  
One external tank (ET)  
One orbiter
5. The external tank (ET).